

Operating Manual UFR1002IP

updated: 2025-05-06 /Sc
 from Firmware: 20-05



For more information and help about this product please scan the [QR-Code](#) or choose the following link [UFR1002IP](#).

Operating manual, Quick guide, Datasheet, Connection diagram, CAD Data, Firmware updates, FAQ, Videos about installation and settings, Certificates

- Network and system protection in accordance with VDE-AR-N 4105 for power generating plants connected to the low-voltage network
- Use on accordance with BDEW + VDE-AR-N 4110 / 4120 / 4130

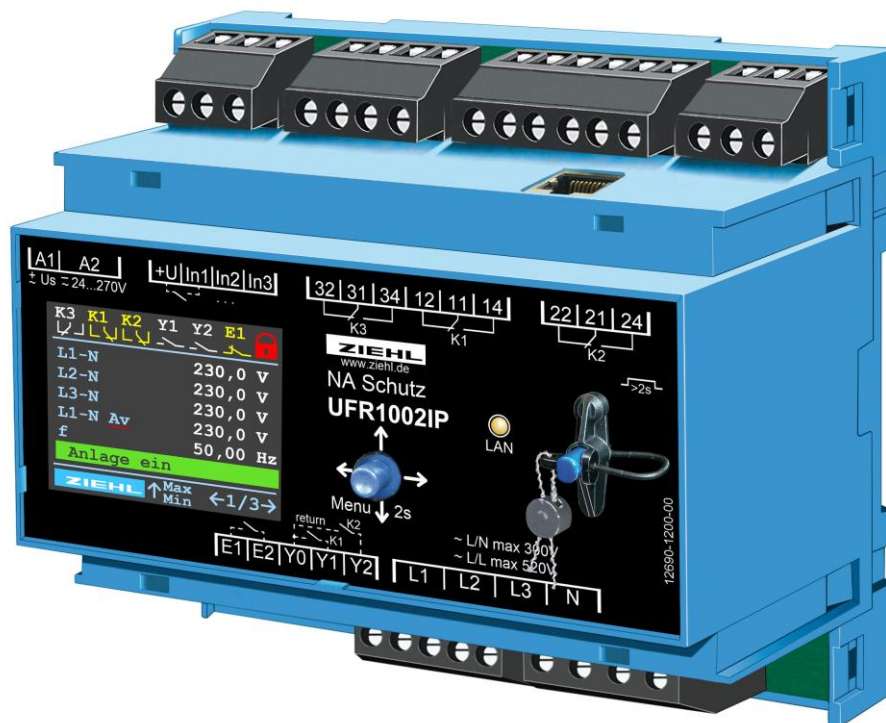

New Firmware 20-03:

- Modus for protection test in programs 2.xx (in connection with VG1200)
- Display of factors (transformation ratio) for protection test without protection test modus

New from Firmware 20-04:

- Device restart possible via menu, Turkish translation (device menu and websites),
- Input E1-E2 can be parameterized to function “U< inactive” (only in programs for VDE-AR-N 4110)

New from Firmware 20-05:

- New function “DI release” with delay time on digital input In1...In3 can be parameterized (VDE-AR-N 4120 / 4130 -> Signal, connection conditions fulfilled at the grid connection point)
- Start signal (Relay K3) also for frequency alarms

Table of contents

1	General Notes	4
2	Display and controls	4
3	Application and short description	5
4	Overview of functions	5
5	Connecting diagram	7
5.1	Ethernet	7
6	Important Information	8
7	Installation	9
8	Commissioning	9
8.1	Switch on the device	9
8.2	Set date / time	9
8.3	Device on the network	9
8.3.1	Find devices on the network	9
8.3.2	Access via web browser	9
8.4	Device operation	10
8.5	Display on device	10
8.6	Menu pages	12
8.6.1	Main menu ("M1" in the lower right display)	12
8.6.2	Submenu ("M2" in the lower right display)	12
8.6.3	Parameter menu ("M3" in the lower right display)	12
8.6.4	Parameter Menu - Value Setting	12
8.7	Programming	13
8.8	Set program	17
8.9	Code lock	19
8.10	Sealing	19
8.11	Simulation	19
8.11.1	Determine shutdown times	20
8.12	Relais K3	20
8.13	Alarm counter	20
8.14	Standby statistics	20
8.15	Relay counter	21
8.16	Firmware update	21
8.17	Program update	21
8.18	Protection test of UFR1002IP in connection with coupling device VG1200	21
8.19	Suppress alarm U< function (U< inactive)	22
9	Web interface	22
9.1	Home	23
9.2	Configuration	23
9.3	System	23
9.4	Network	23
9.5	User	23
9.5.1	User, admin forgot password	24

9.6 Counter	24
10 Error search	25
11 Technical data	26
12 Housing Type V6	29
13 Disposal	29
14 Adjustment values according to VDE and BDEW	30
14.1 VDE-AR-N 4105:2011, Section 6.5.2, Low Voltage – Pr1.01 + Pr1.07.....	30
14.2 BDEW June 2008, acc. 3.2.3.3-1, Medium Voltage – Pr1.03 ... Pr1.06.....	30
14.3 VDE-AR-N 4105:2018-11 Low Voltage, acc. 6. table 2 – Pr1.02.....	30
14.4 VDE-AR-N 4110:2018-11 + 4110:2023-09 Medium Voltage.....	31
14.5 VDE-AR-N 4110:2018-11 + 4110:2023-09 Medium Voltage, Unit Protection Pr 1.13 + 1.14.....	31
14.6 VDE-AR-N 4120:2018-11 High voltage, Unit Protection	32
14.7 VDE-AR-N 4130:2018-11 Maximum voltage, Unit Protection	32
15 Default settings of the programs.....	33
15.1 VDE-AR-N 4105:2011+2018	33
15.2 BDEW	37
15.3 VDE-AR-N 4110:2018-11 + VDE-AR-N 4110:2023-09	41
15.4 VDE-AR-N 4120:2018-11	45
15.5 VDE-AR-N 4130:2018-11	49
15.6 TOR Erzeuger Typ A,B,C,D + NA/EEA-NE7 CH 2020 + C10/C11 + G98(G83/2)+G99(G59/3)	53
15.7 SFS-EN50549-1+2:2019 + EN50549-1 2-stage + NEN-EN50549-1:2019 + VDE 0126 VFR2019 .	57
15.8 NRS 097-2-1:2010 + NRS 097-2-1:2024 + AS4777,2.....	61
15.9 RD647/2020 + Western/Eastern Denmark DK 1/DK 2 Typ A + B + C + D	65
15.10 With coupling device VG1200 - VDE-AR-N 4110:2018-11 + VDE-AR-N 4110:2023-09.....	69
15.11 With coupling device VG1200 - VDE-AR-N 4120:2018-11.....	73
15.12 With coupling device VG1200 - VDE-AR-N 4130:2018-11.....	77

1 General Notes

Compliance with the following instructions is mandatory to ensure the functionality and safety of the product. If the following instructions given especially but not limited for general safety, transport, storage, mounting, operating conditions, commissioning and disposal / recycling are not observed, the product may not operate safely and may cause a hazard to the life and limb of users and third parties.

Deviations from the following requirements may therefore lead both to the loss of the statutory material defect liability rights and to the liability of the buyer for the product that has become unsafe due to the deviation from the specifications.

2 Display and controls

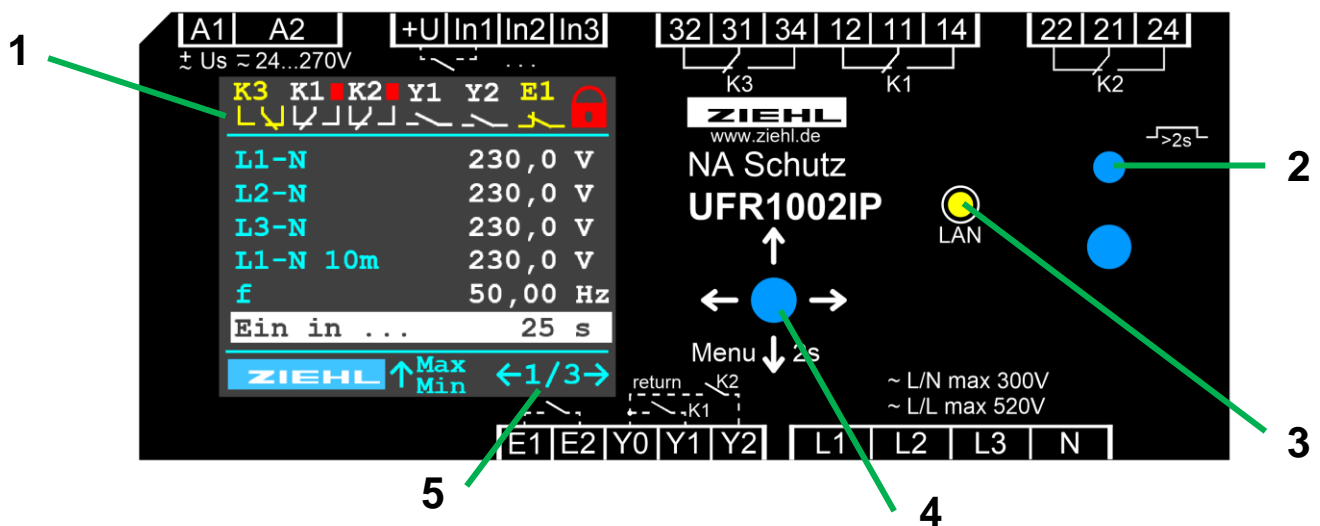

- 1 Display - Color display
- 2 Button for device protection by sealing
- 3 LED – Ethernet connectivity
- 4 Control element - Joystick button, press the down arrow key (↓) for 2 seconds to call up settings menu
- 5 Page display (display page / of display pages),
Press the left (←) or right (→) joystick button to change the display page

3 Application and short description

The UFR1002IP mains decoupling relay monitors voltage and frequency in three-phase networks and complies with the conditions for central network and system protection in accordance with VDE-AR-N 4105:2018-11 for feeding into the low-voltage network.

For feeding into the medium-voltage network in accordance with VDE-AR-N 4110:2018-11, the UFR1001E is suitable as unit protection at the generating units and as intermediate decoupling protection.

The device has a dual-channel single fault safety design, thereby meeting the requirements of VDE-AR-N 4105:2018-11. The function of the connected switch is monitored. When monitoring is enabled, the device does not switch on again if a switch-off error is detected.

Limit values for different applications are preset. They can be easily changed where permitted. If the rated voltage is changed, the device automatically adjusts the preset limit values. The standby input allows a remote shutdown, such as with a ripple-control receiver.

With a colour LCD display (German/English) and joystick, it is easy to operate.

Measured values and settings are clearly displayed.

Via the integrated IP interface, the device can be programmed, updates installed and the alarm buffer read out. The real-time clock (with power reserve) thereby facilitates the alarms' traceability. In conjunction with the coupling device VG1200, a voltage of up to 1,200 V can be monitored.

4 Overview of functions

Monitoring functions:

- Undervoltage / overvoltage 15...520 V
 - 1, 2 or 3 phase , measurement phase-N and/or phase-phase
- Underfrequency / overfrequency 45...65 Hz
- Voltage quality (10-minute mean value)
- Vector shift 2...65°, 1 or 3 phase
- Frequency gradient (ROCOF) df/dt 0.100...5.000 Hz/s

Default settings (easy start-up and configuring by preset programs):

Germany:

- Program Pr1.02 VDE-AR-N 4105:2018-11
- Program Pr1.08 / Pr1.09 VDE-AR-N 4105:2018-11, Generator $P_n \leq 50$ kW / $P_n > 50$ kW
- Program Pr1.01 VDE-AR-N 4105-2012
- Program Pr1.11...Pr1.14 VDE-AR-N 4110:2018-11 + 4110 :2023-09
- Program Pr2.00...2.11 VDE-AR-N 4110:2018-11 + 4110 :2023-09
- Program Pr1.03...Pr1.06 BDEW-Richtlinie
- Program Pr1.66...Pr1.69 VDE-AR-N 4120:2018-11
- Program Pr2.30...Pr2.32 VDE-AR-N 4120:2018-11
- Program Pr1.60...Pr1.63 VDE-AR-N 4130:2018-11
- Program Pr2.20...Pr2.22 VDE-AR-N 4130:2018-11
- Austria:
 - Program Pr1.10 = TOR Erzeuger Typ A,B,C,D)
 - Program Pr1.10 = ÖVE/ÖNORM E 8001-4-712 (adjustment required)
- Great Britain: Program Pr1.20...1.23 G98(G83/2) + G99(G59/3)
- Switzerland: Program Pr1.15 = NA/EEANE7 CH 2020
- Belgium: Program Pr1.16 Synergrid C10/C11
- Finland: Program Pr1.30 and Pr1.31 SFS-EN50549-1+2:2019
- Ireland: Program Pr1.31 and Pr1.32 EN50549-1 2-stage
- Nederland: Program Pr1.34 NEN-EN50549-1:2019
- France: Program Pr1.36 VDE 0126 VFR2019
- South Africa: Program Pr1.40 and Pr1.41 NRS 097-2-1:2010
- Program Pr1.50 ... Pr1.53 NRS 097-2-1:2024
- Australia: Program Pr1.42 AS4777,2
- Denmark: Program Pr1.55 ... Pr1.59 Western (DK 1) / Eastern (DK 2), Typ A, B, C, D
- Spain: Program Pr1.44 and Pr1.45 RD647/2020

Logging:

- Alarm counter (resettable)
 - Memory for number of alarms (resettable)
 - Memory for 100 alarms (shutdowns)
 - Storage of trigger value, cause, time stamp of shutdown and time stamp of reconnection
 - Total alarm time (resettable)
- Standby statistics (shutdowns via digital input E1/E2)
 - Memory for number of standby events (resettable)
 - Memory for 10 standby shutdowns
 - Storage of time stamp for shutdown and time stamp for reconnection
 - Total time for standby (resettable)

Ethernet interface:

- integrated web server, for
 - Display of measured values
 - Display of operating states
 - Programming
 - Simulation
 - Display alarm counter and standby counter (with csv download)
 - Firmware Updates
 - Updates for programs (default settings)
 - saving and transferring device configurations
- Modbus TCP (read)

Display and operation

- colour LCD display for displaying the operating conditions and for programming
- intuitive operations via joystick
- convenient display of operating conditions
- Programming via Ethernet interface on the PC (web browser) is possible

Other features:

- Single fault safety
- Monitoring of section switches (can be switched off when using the integrated section switches of PV and battery inverters in accordance with DIN EN 62109 (VDE 0126-4))
- Standby input
- Restart attempts for power-on error, number adjustable, 0...3
- passive stand-alone network detection in accordance with Chapter 6.5.3 from VDE-AR-N 4105
- Test and simulation functions with measurement of shutdown times
- Adjustable response times, 0.05...300.0 s
- Adjustable reset times, 0...6000 s
- Protection of device settings by sealing and code protection (values can still be read)
- Integrated real-time clock (power reserve > 11 days at 25°C)
- Connection of a Ziehl coupling device VG1200 for measuring max. 875 V (Ph-N) or 1500 V (Ph-Ph) is possible
- Change of the rated voltage during program setting -> voltage alarms are automatically adjusted
- Control voltage AC/DC 24-270 V
- Distribution box V6, 6 TE, 105 mm wide, installation depth 66 mm

5 Connecting diagram

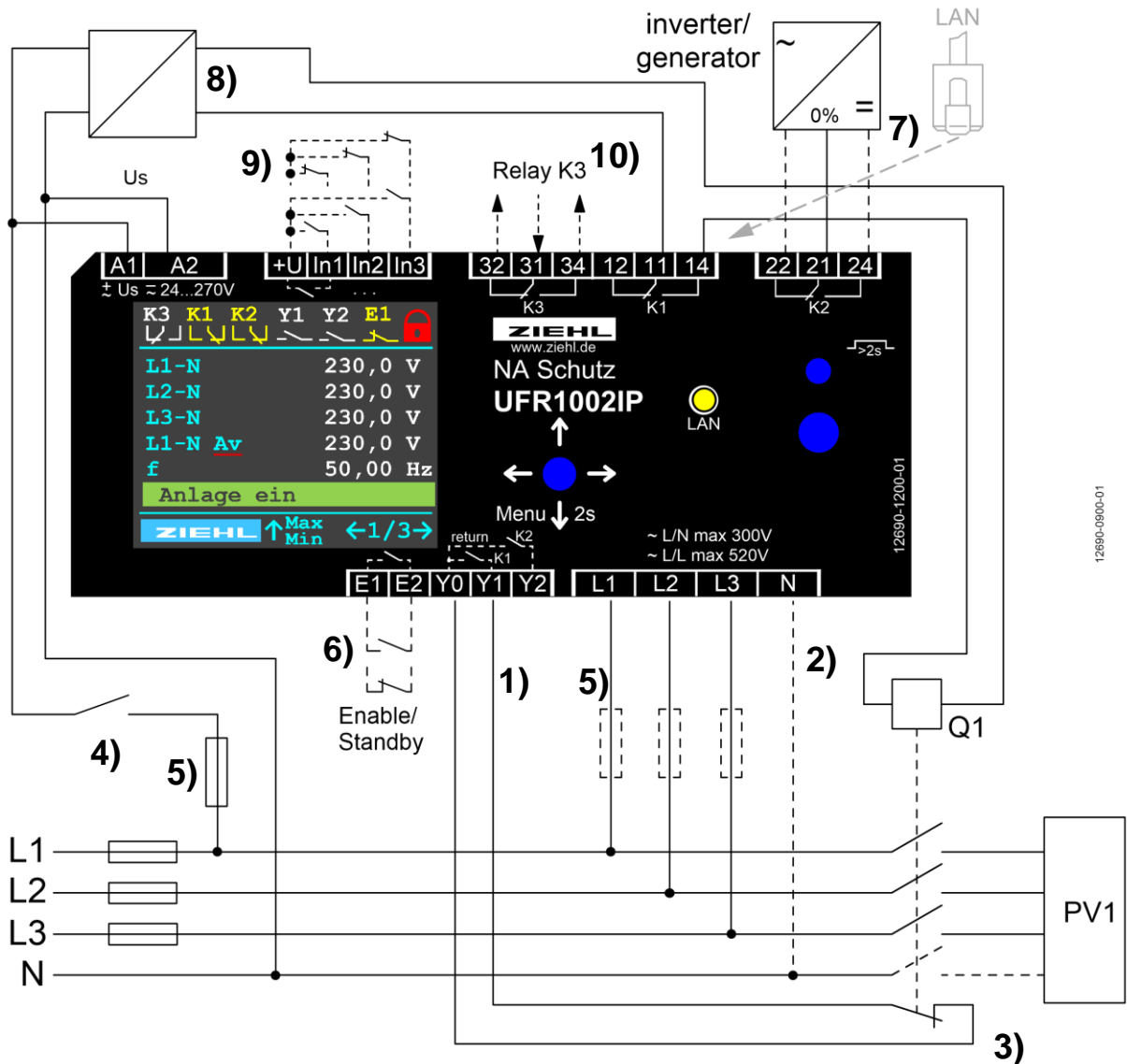

12690-0900-01

- 1) Feedback contacts Y0-Y1 / Y0-Y2, (programmable: Off, Normally closed (NC) or Normally open (NO))
- 2) Connecting to programs with N
- 3) Optional use of NO/NC contacts possible (automatic detection)
- 4) Safe system shutdown (with alarm recording)
- 5) Fuses only if cable protection is required, e.g. 16 A
- 6) Standby (programmable, normally closed or normally open), K1 + K2 dropped (e.g. by ripple-control receiver, timer, ...)
- 7) Single fault safety: Shutdown of the power generating plant, e.g. via ripple control input 0% with K2. Use coupling relays when contact multiplication or safe disconnection is required. This second shutdown method must be tested separately during startup.
- 8) Power supply / buffering. Section switches must be supported in case of undervoltage for at least 3 s / 0.3 s (FRT)
- 9) Digital inputs (programmable) for suppression of feedback contacts Y1, Y2, reset enable signal and vector shift
- 10) Function of relay K3 programmable

5.1 Ethernet

Ethernet socket for network cables



6 Important Information

To use the equipment flawless and safe, transport and store properly, install and start professionally and operate as directed.

Only let persons work with the equipment who are familiar with installation, start and use and who have appropriate qualification corresponding to their function. They must observe the contents of the instructions manual, the information which are written on the equipment and the relevant security instructions for the setting up and the use of electrical units.

The equipment is built according to DIN VDE/EN/IEC and checked and leave the plant according to security in perfect condition. If, in any case the information in the instructions manual is not sufficient, please contact our company or the responsible representative.

In order to maintain this status, you must observe the safety regulations entitled "caution" in this operating manual. Failures to follow the safety regulations can result in death, personal injury or property damage to the device itself and to other devices and facilities.

To maintain this condition, you must observe the safety instructions in this instruction manual titled "Important Information". Failure to follow the safety instructions may result in death, personal injury, or property damage to the equipment itself and other equipment and facilities.

Instead of the industrial norms and regulations written in this instruction manual valid for Europe, you must observe out of their geographical scope the valid and relevant regulations of the corresponding country.



DANGER!

Hazardous voltage!

Will cause death or serious injury. Turn off and lock out all power supplying this device before working on this device.



Attention! Universal power supply

The device have a universal power supply, that is suitable for DC- and AC-voltages. Before connecting the device to supply-voltage make sure that the connected voltage corresponds with the voltage on the lateral type on the device.



The measurement inputs L1, L2, L3 and N have no potential separation to the inputs E1, E2, Y0, Y1 and Y2.

The digital inputs +U, In1, In2, In3 and Ethernet have no potential separation/isolation.



A circuit-breaker or switch must be situated within easy reach of the unit and fused. Installation excess current protection should be ≤ 10 A.

Comply with the maximum permissible temperature when installing in a switch cabinet. Ensure sufficient clearance to other devices or heat sources. If cooling is inhibited, e.g., through close proximity to devices with increased surface temperature or interference with the cooling-air current, the permissible ambient temperature is decreased.

7 Installation

- mount on 35 mm mounting rail according to EN 60715
- wall-mount with 3 x screws M4
- connecting wires refer to the connection plan to prevent miss-operation and malfunction

8 Commissioning

8.1 Switch on the device

Switch on the supply voltage,

- The display turns on, after about 1s the device is ready for use
- The device language must be specified during initial startup. Use the joystick button to navigate to the language you want (German/English) and select.

8.2 Set date / time

We recommend setting the date and time.

Functions such as the alarm counter and standby statistics require a correct date/time.

If a valid date/time is not yet stored in the device, you will be asked to enter the date/time. Use the joystick button to make the appropriate settings and confirm these using the green tick. After 2 minutes without input, the query is terminated. The settings can also be changed at any time via the "Settings" -> "Date" or "Time" menu. If the device (with connected Ethernet cable) receives valid network data via DHCP, it automatically tries to contact a time server to get the current date/time from there.

8.3 Device on the network

If the UFR1002IP is connected to a network via an Ethernet, the measured value display and programming can be performed via a web browser on the computer. Basic knowledge of network engineering is required for configuration.

8.3.1 Find devices on the network

Network with DHCP server:

After connecting to the network, the device will automatically receive an IP address.

Retrieve IP address on the device:

- Use the joystick (←/→) on the device to switch to the info display page
 - IP address is displayed
- In menu mode (press and hold the joystick for ↓ 2 s), call up the menu item "Network"
 - Settings for the network parameters DHCP, IP address and subnet mask can be viewed and changed

Set network without DHCP server / manual IP address:

The relevant network parameters can be set and changed directly on the device:

- In menu mode, call up the menu item "Network"
- Configure the network parameters DHCP, IP address and subnet mask

Connection:

Open the web browser on the computer and enter the IP address in the address bar.

8.3.2 Access via web browser

After the IP address is accessed, the device logs on to the web browser. Internet access should be secured using a VPN connection.

8.4 Device operation

The device is operated via the integrated joystick button. It can be operated in four directions (up, down, left and right). In conjunction with the graphical colour display, operation of the device is easy and intuitive.

↑ *Actuation upwards...*

Display page: if necessary, display min./max. values

Menu: Scroll up

Parameter: Increase value

← *Actuation to the left...*

Display Page: Previous Display

Menu: back

Parameter: navigate left

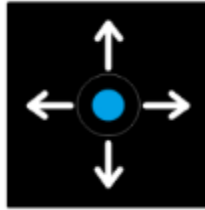

→ *Actuation to the right...*

Page Display Page: Next Display Page

Menu: Call up submenu/parameter

Parameter: navigate right

↓ *Actuation downwards...*

Display page: Press and hold for 2 seconds to call up the menu

Menu: Scroll down

Parameter: Decrease value

Navigate between display pages:

← →

Call up menu:

Press and hold ↓ for 2 seconds

8.5 Display on device

Display pages

A Measurement L-N

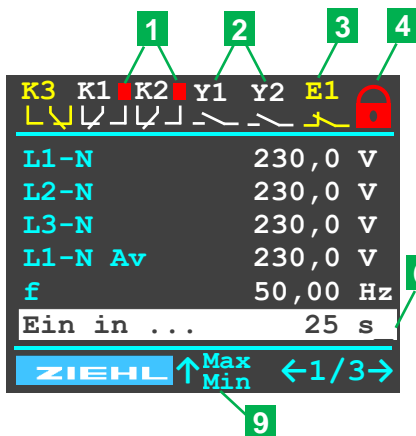

B Measurement L-L

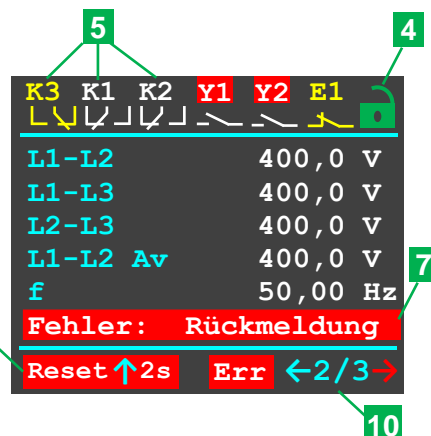

C Measurement vector shift



D Info page



E Error page

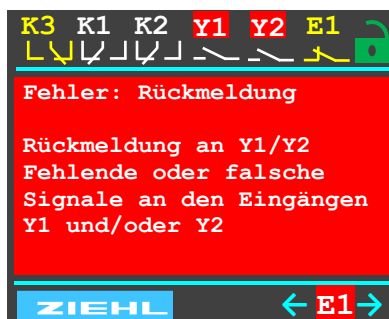

8.6 Menu pages

8.6.1 Main menu ("M1" in the lower right display)

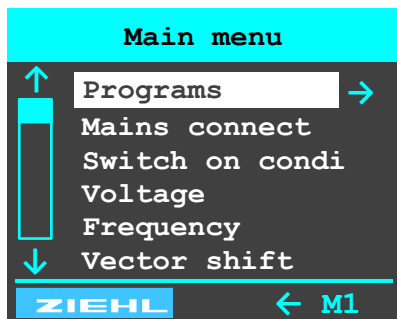

Call up the main menu:

Press ↓ for 2s

Exit main menu:

Press ←
(back to the display pages)

Call up submenu:

Press →

Navigate within the main menu:

- Press ↓ down
- Press ↑ up

8.6.2 Submenu ("M2" in the lower right display)

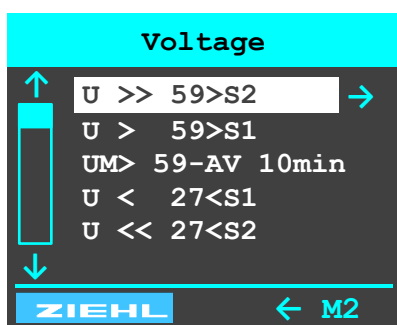

Call up submenu:

From the main menu, select the submenu and press →

Exit submenu:

Press ←
(back to the main menu)

Call up parameter menu:

Press →

Navigate within the submenu:

- Press ↓ down
- Press ↑ up

8.6.3 Parameter menu ("M3" in the lower right display)

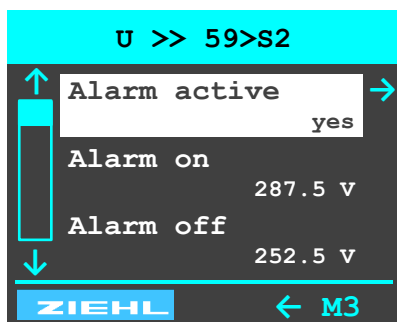

Call up parameter menu:

Call up parameter menu:

Exit parameter menu:

Exit parameter menu:

Call up value settings:

Call up value settings:

Navigate within the parameter menu:

- Navigate within the parameter menu:

8.6.4 Parameter Menu - Value Setting

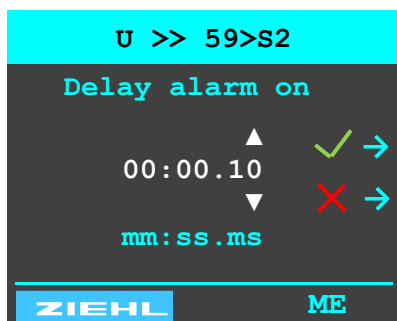

Call up value settings:

From the submenu, select the parameters and → press

Navigate to value settings:

- To shift to the left, press ←
- To shift to the right, press →
- Increase value, press ↑
- Decrease value, press ↓

Change value:

Exit value setting:

Press right → (several times) until the green tick is activated. Using the ↓ / ↑ keys, select the **X** (discard change) or the **tick** (save changes) and leave by pressing →

e.g.
minutes : seconds. milliseconds

8.7 Programming

The device is programmed in the menu mode.

In menu mode, the joystick button can be used to navigate easily and intuitively between the main menu, submenu and parameter menu.

Call up main menu: Press and hold the joystick button ↓ for 2 s (starting from a display page)

Back to display pages: Briefly press the joystick button ← (starting from the main menu)

Below is the menu structure with descriptions of the parameters.

Main Menu			
Submenu	parameter menu	Setting range	Parameter description
Programs			
			Select the program you want using the ↓/↑ keys and confirm by pressing →. Then select between the options "set" and "change voltage" (rated voltage) and set the program by pressing 2x → (rated voltage is requested after the program change if necessary).
Mains connect (Mains connection)			
	Connection	3 AC-N / 3 AC-N + 3 AC / 3 AC / 1 AC-N	These parameters are permanently stored in the program and cannot be changed. Exception: Nominal voltage when changing a program
	Nominal voltage	30,0 ... 500,0 V	
	Coupling device	yes / no	
Switch on condi (Switch on condition)			
Voltage	Active	yes / no	Connection conditions: The limit values for these parameters must be met after the device has been started so that the K1 and K2 relays can switch on after the switch-on delay has elapsed
	U max	15,0 ... 520,0 V	
	U in.	15,0 ... 520,0 V	
Frequency	Active	yes / no	
	F max.	45,00 ... 65,00 Hz	
	F min.	45,00 ... 65,00 Hz	
Switch on delay	Time	0 ... 6000 s	
After alarms	Switch back	activated / all f + U < + U <<	activated: Device switches on again as soon as the "alarm off" value of the activated alarm is reached all f + U < + U <<: Device switches on again as soon as all "Alarm off" values of the frequency alarms and voltage alarms U <, U << are reached
Short alarm	Active	yes / no	Only visible in program Pr1.01 and Pr1.07: For short alarms a shorter reset time can be realized
Voltage			
U >> 59>S2	Alarm active	yes / no	Voltage alarms: <ul style="list-style-type: none"> • U >> (larger larger) • U > (larger) • U 10 minutes mean value • U < (smaller) • U << (smaller smaller) • U0 (zero voltage)
	Alarm on	15,0 ... 520,0 V	
	Alarm off	15,0 ... 520,0 V	
	Delay alarm on	0,05 ... 300,00 s	
	Delay alarm off	0 ... 6000 s	
U > 59>S1	Alarm active	yes / no	
	Alarm on	15,0 ... 520,0 V	
	Alarm off	15,0 ... 520,0 V	
	Delay alarm on	0,05 ... 300,00 s	
	Delay alarm off	0 ... 6000 s	
UM> 59-Av 10Min	Alarm active	yes / no	
	Alarm on	15,0 ... 520,0 V	
	Alarm off	15,0 ... 520,0 V	
	Delay alarm on	0,05 ... 300,00 s	
	Delay alarm off	0 ... 6000 s	

U < 27<S1	Alarm active Alarm on Alarm off Delay alarm on Delay alarm off	yes / no 15,0 ... 520,0 V 15,0 ... 520,0 V 0,05 ... 300,00 s 0 ... 6000 s	Parameter: <ul style="list-style-type: none"> Alarm active yes / no Alarm on limit value Alarm on Alarm off limit value Alarm off Delay Alarm on Alarm for this period is delayed Delay Alarm off Alarm off for this period is delayed
U << 27<S2	Alarm active Alarm on Alarm off Delay alarm on Delay alarm off	yes / no 15,0 ... 520,0 V 15,0 ... 520,0 V 0,05 ... 300,00 s 0 ... 6000 s	
U0 59v0	Alarm active Alarm on Alarm off Delay alarm on Delay alarm off	yes / no 1,0 ... 300,0 V 1,0 ... 300,0 V 0,05 ... 300,00 s 0 ... 6000 s	
	Display U0/UM>	U0 / UM> / 2,0 ... 600,0 s	Measured value on display page (sequentially in time). Only visible, when U0 and UM> are active (on)
Frequency			
f >> 81>S2	Alarm active Alarm on Alarm off Delay alarm on Delay alarm off	yes / no 45,00 ... 65,00 Hz 45,00 ... 65,00 Hz 0,05 ... 300,00 s 0 ... 6000 s	Frequency alarms: <ul style="list-style-type: none"> f >> (bigger bigger) f > (larger) f < (smaller) f << (smaller smaller) Parameter: <ul style="list-style-type: none"> Alarm active yes / no Alarm on limit value Alarm on Alarm off limit value Alarm off Delayed Alarm on Alarm for this period is delayed Delayed Alarm off Alarm off for this period is delayed
f > 81>S1	Alarm active Alarm on Alarm off Delay alarm on Delay alarm off	yes / no 45,00 ... 65,00 Hz 45,00 ... 65,00 Hz 0,05 ... 300,00 s 0 ... 6000 s	
f < 81<S1	Alarm active Alarm on Alarm off Delay alarm on Delay alarm off	yes / no 45,00 ... 65,00 Hz 45,00 ... 65,00 Hz 0,05 ... 300,00 s 0 ... 6000 s	
f << 81<S2	Alarm active Alarm on Alarm off Delay alarm on Delay alarm off	yes / no 45,00 ... 65,00 Hz 45,00 ... 65,00 Hz 0,05 ... 300,00 s 0 ... 6000 s	
f/U< Schutz	Alarm active U< Limit	yes / no 10,0 ... 320,0 V	
Vector shift			
	Alarm active VSR deg Delay alarm off Suppression	yes / no 2,0 ... 65,0 ° 3 ... 240 s 2 ... 20 s	<ul style="list-style-type: none"> ➔ Alarm vector shift active yes / no ➔ Angle limit value ➔ Alarm off is delayed for this period ➔ Suppression time when switching on or when changing to digital input (if programmed)
ROCOF			
	Alarm active df / dt Periods	yes / no 0,100 ... 5,00 Hz/s 4 ... 50	<ul style="list-style-type: none"> ➔ Alarm ROCOF active yes / no ➔ Limit value for ROCOF ➔ Number of periods: 4 = sensitive, 50 = insensitive

	Delay alarm on	0,05 ... 300,00 s	→ Measurement duration = number of periods * Period duration + delayed Alarm on
	Delay alarm off	0 ... 6000 s	→ Alarm off is delayed for this period
Feedback			
	Feedback at	off/Y1+Y2/Y1/Y2	→ Feedback contacts: off / Y1+Y2 / Y1 / Y2
	Time for feedb.	K1/2 off only / 0,5 ... 999,0 s	→ Only the switching off of the relays K1/K2 is monitored at the feedback inputs Y1 and/or Y2 → Time after switching on K1 and K2 until feedback must have been given
	Reclosing attempt	0 ... 3	→ Number of restart attempts (only visible if "Time for feedb." ≥ 0,5 s)
	Reclosing time	5 ... 59 s	→ Time between restart attempts (only visible if "Time for feedb." ≥ 0,5 s)
Relay K3			
	Relay function	Duration on / Pulse on / K1 = K2 = K3 / in case of error / Life contact / Start signal / Enable signal	→ K3 static ON (after time "K3 to K1+K2") → K3 for time "K3 pulse" on (after time "K3 to K1+K2") → K3 switches on synchronously with K1/K2 → K3 on when an error occurs → K3 off when an error occurs → If the limit value is exceeded, K3 switches from U and f (>>, >, <, <<) without delay → K3 picks up at this time after K1 + K2 with a delay, only visible if "Pulse on"/"Duration on" is selected
	K3 pulse	0,5 ... 10,0 s	→ Pulse duration of K3 (only visible if "Relay function" = "Pulse on")
	K3 after K1 + K2	0,0 ... 60,0 s	→ K3 picks up at this time after K1 + K2 with a delay (only visible if "Relay function" = "Pulse on" / "Duration on")
Digital Inputs			
E1-E2	Type	norm. open / close	
	Function	System off U< inactive	→ Switch off the system (relay K1 and K2 = off) → Suppress alarm "U<" (only available for programs for VDE-AR-N 4110)
In1	Type	norm. open / close	Function In1 ... In3: <ul style="list-style-type: none"> • off (Digital input without function) • Y1 inactive (Y1 evaluation off) ^{*1)} • Y2 inactive (Y2 evaluation off) ^{*1)} • Y1+Y2 inactive (Y1 and Y2 evaluations off) ^{*1)} • VSR inactive (alarm vector shift off) • Release signal for relay K3 (external reset) • DI Release: System (relays K1 and K2) only switches on after release at E1-E2 (if no alarm is active and after the "Switch-on delay" time). <i>*1) the switching off of relays K1/K2 continues to be monitored at feedback inputs Y1 and/or Y2</i>
	Function	→	
	Switch on delay	0 ... 6000 s	
In2	Type	norm. open / close	<ul style="list-style-type: none"> • Y1+Y2 inactive (Y1 and Y2 evaluations off) ^{*1)} • VSR inactive (alarm vector shift off) • Release signal for relay K3 (external reset) • DI Release: System (relays K1 and K2) only switches on after release at E1-E2 (if no alarm is active and after the "Switch-on delay" time). <i>*1) the switching off of relays K1/K2 continues to be monitored at feedback inputs Y1 and/or Y2</i>
	Function	→	
	Switch on delay	0 ... 6000 s	
In3	Type	norm. open / close	<ul style="list-style-type: none"> • Y1+Y2 inactive (Y1 and Y2 evaluations off) ^{*1)} • VSR inactive (alarm vector shift off) • Release signal for relay K3 (external reset) • DI Release: System (relays K1 and K2) only switches on after release at E1-E2 (if no alarm is active and after the "Switch-on delay" time). <i>*1) the switching off of relays K1/K2 continues to be monitored at feedback inputs Y1 and/or Y2</i>
	Function	→	
	Switch on delay	0 ... 6000 s	
Network			
	Network	on / off	Network connection switch on/off
	DHCP	on / off	Ethernet network configuration:
	IP address	xxx.xxx.xxx.xxx	DHCP on: Automatically secure network configuration from a DHCP server
	Subnet mask	xxx.xxx.xxx.xxx	DHCP off: manual network configuration
	Gateway	xxx.xxx.xxx.xxx	
	DNS server	xxx.xxx.xxx.xxx	
	MAC address	00:12:e4:xx:xx:xx	Display of the MAC address of the device
Settings			
	Language	Deutsch / English / Türk	→ Device language: German / English / Turkish
	Date	YYYY-MM-TT	→ Date from real time clock

	Time	hh:mm:ss	→ Time from real time clock
	Display interval	0,1 ... 2,0 s	→ Interval at which measured values are updated on the device display
	Brightness	20 ... 100 %	→ Brightness of the display is turned down after dimming time without a button being pressed
	Dimming time	10 ... 3600 s	→ Reset device to factory default
	Factory setting	yes / no	→ The device restarts
	Restart	yes / no	→ When the code lock is changed, the previously set pin must always be entered, Factory default Codepin = 504.
	Code lock	on / off, Codepin	→ Forgot your codepin? Switch the device off and on again, keeping the joystick up button pressed (↑) until "Reset" appears on the display. Select code lock and reset to factory default with → key.
Test/simulation			
	Relay	start...	→ Simulation relay
	Simulation	start...	→ Simulation voltage, frequency and vector shift
	Test K1/K2	start...	→ Shutdown tests of the Relay K1 and K2, measure shutdown times of K1->Y1 and K2-Y2
	Protection test	start...	Only visible in program with Coupling Device VG1200: → Start/stop protection test without VG1200 with fixed voltage factor of 4.5. The test ends automatically after 15 minutes.
	Switch back time	0 ... 6000 s	→ Set all "Delayed alarm off" of voltage and frequency alarms together
Info			
	Firmware version	display	→ Firmware versions installed on the device <ul style="list-style-type: none"> • Firmware version 12690-1420-xx • Firmware M: 12690-1400-xx • Firmware S: 12690-1410-xx • Firmware BL: 12750-1400-xx
	Serial number	xxxxxxx	→ Device serial number
	Operating hours	xxxxxx	→ Number of operating hours of the device
	VG1200 factor	display	Only visible in program with Coupling Device VG1200: → Factors for protection test without VG 1200. Factor for test voltage at L1-N, L2-N, L3-N, L1-L2, L2-L3 and L3-L1
	Comment		→ Comment can only be written via website
Counter			
Alarm	Last reset	Date + Time	→ Date + time of last reset
	Number	sum	→ Number of alarms since last reset
	List	display	→ List of alarms with cause of shutdown, measured value and time stamp as well as the restart time (K1+K2 on)
	Time sum		→ Time in alarm status since last reset
	Reset	yes	→ Reset alarm counter (number, list and total time)
Standby	Last reset	Date + Time	→ Date + time of last reset
	Number	sum	→ Number of standbys since last reset
	List	display	→ List of standby on and standby off, each with timestamp
	Time sum		→ Standby time since last reset
	Reset	yes	→ Reset standby counter (number, list + total time)
Relay	Last reset	Date + Time	→ Date + time of last reset
	List	display	→ Display of relay switching operations, "Number" (since last reset) and "Total"
	Reset	yes	→ Reset relay counter

8.8 Set program

Depending on the application, the appropriate program must be set on the UFR1002IP.

If the UFR1002IP is locked by sealing (red lock in the upper right display), it must be deactivated first.

Country	Program	Connection	Rated voltage	Standard	
	1.02	3 AC with N	230 V	VDE-AR-N 4105:2018	
	1.01	3 AC with N	230 V	VDE-AR-N 4105:2011	
	1.07	1 AC with N	230 V		
	1.08	3 AC with N	230 V	VDE-AR-N 4105:2018, Generator Pn ≤ 50 kW	
	1.09	3 AC with N	230 V	VDE-AR-N 4105:2018, Generator Pn > 50 kW	
	1.17	3 AC with N	230 V	VDE-AR-N 4105:2018, EAAV ≤ 500 kW	
	1.03	3 AC with N	57,7 V	BDEW Juni 2008 nach 3.2.3.3-1	
	1.04	3 AC without N	100 V		
	1.05	3 AC with N	230 V		
	1.06	3 AC without N	400 V		
	1.11	3 AC with N	57,7 V	VDE-AR-N 4110:2018, VDE-AR-N 4110:2023 higher protection device	
	1.12	3 AC without N	100 V		
	1.13	3 AC with N	230 V	VDE-AR-N 4110:2018, VDE-AR-N 4110:2023 intermediate decoupling protection on the generation units	
	1.14	3 AC without N	400 V		
	2.00	3 AC without N (with VG1200)	690 V		
	2.01		800 V		
	2.02		1000 V		
	2.10	3 AC with N	400 V		
	2.11	(with VG1200)	460 V		
	1.66	3 AC with N	57,7 V		VDE-AR-N 4120:2018-11 intermediate decoupling protection on the generation units
	1.67	3 AC without N	100 V		
	1.68	3 AC with N	230 V		
	1.69	3 AC without N	400 V		
	2.30	3 AC without N with VG1200)	480 V		
	2.31		690 V		
	2.22		800 V		
	1.60	3 AC with N	57,7 V	VDE-AR-N 4130:2018-11 intermediate decoupling protection on the generation units	
	1.61	3 AC without N	100 V		
	1.62	3 AC with N	230 V		
	1.63	3 AC without N	400 V		
	2.20	3 AC without N with VG1200)	480 V		
	2.21		690 V		
2.22	800 V				

set ex works

Country	Program	Connection	Rated voltage	Standard	
	1.10	3 AC with N	230 V	TOR Erzeuger Typ A, B, C, D	
	1.15	3 AC with N	230 V	NA/EEA-NE7 CH 2020	
	1.20	3 AC with N	230 V	G98(G83/2) + G99(G59/3)	
	1.21	3 AC without N	400 V		
	1.22	3 AC with N	63,5 V		
	1.23	3 AC without N	110 V		
	1.16	3 AC with N	230 V	Synergrid C10/C11	
	1.30	3 AC with N	230 V	SFS-EN50549-1+2:2019	
	1.31	3 AC without N	400 V		
	1.32	3 AC with N	230 V	EN50549-1 2-stage	
	1.33	3 AC without N	400 V		
	1.34	3 AC with N	230 V	NEN-EN50549-1:2019	
	1.36	3 AC with N	230 V	VDE 0126 VFR2019	
	1.40	3 AC with N	230 V	NRS 097-2-1:2010	
	1.41	3 AC without N	400 V		
	1.50	3 AC with N	230 V	A1 + A2	NRS 097-2-1:2024
	1.51	3 AC without N	400 V	A1 + A2	
	1.52	3 AC with N	230 V	A3	
	1.53	3 AC without N	400 V	A3	
	1.42	3 AC with N	230 V	AS4777,2	
	1.44	3 AC with N	230 V	RD647/2020	
	1.45	3 AC without N	400 V		
	1.55	3 AC with N	230 V	Western Denmark DK 1 Typ A, Typ B	
	1.56	3 AC with N	230 V	Western Denmark DK 1 Typ C	
	1.57	3 AC with N	230 V	Eastern Denmark DK 2 Typ A, Typ B	
	1.58	3 AC with N	230 V	Eastern Denmark DK 2 Typ C	
	1.59	3 AC with N	230 V	Denmark Typ D	

8.9 Code lock

The parameters set (including simulation) can be protected using the code lock.

On the website:

Code protected parameters are marked with a .

Switch the "System" -> "Code lock" page on/off

The old/new pin is requested. if necessary. Apply changes by clicking the "Save" button.

On the device:

When the code lock is active, a "Code lock" message appears when you try to change a parameter.

- Call up the "Settings" -> "Code lock" menu
- Switch code lock on/off
- When the code lock is changed, the previously set pin must always be entered
 - **Factory default codepin = 504**
 - Forgot your codepin? Switch the device off and on again, keeping the joystick up button pressed (↑) until "Reset" appears on the display. Select code lock and reset to factory default by pressing „→“
- Switch on code lock: Enter new codepin and save by pressing ✓

8.10 Sealing

The parameters set (including simulation) can be locked by means of the sealing.

On the website:

Sealed parameters are marked with a .

On the device:

If sealing is active, a "Sealing" message appears when an attempt is made to change a parameter.

- Sealing/locking ON (OFF) setting procedure
 - If present, remove the seal (only by an authorized person)
 - Lift the button cover slightly and turn it 180°
 - Press the button by pressing very firmly on the button cover (the lock in the top right hand corner of the display will start to flash), keep the button pressed
 - The colour changes from red to green (green = sealing off)
 - The colour changes from green to red (red = sealing active)
 - Release button
 - Apply new sealing if necessary

8.11 Simulation

Comprehensive simulation functions are available to test the correct functioning of the device.

The simulation can be carried out via the web interface or directly on the device.

Web interface: "Home" page -> "Start simulation" button

Device: "Test/Simulation" menu

- Simulation relay
 - Access on the device: Menu "Test/Simulation" -> "Start relay"
 - Relays can be individually switched on/off
- Simulation of measured values
 - Access on the device: Menu "Test/Simulation" -> "Start simulation"
 - Voltage (U), frequency (F) and vector shift (VS) can be simulated

8.11.1 Determine shutdown times

The system shutdown time is automatically measured with connected feedback contacts and activated feedback (menu "Feedback" -> "Message on" = $Y1 / Y2 / Y1+Y2$).
These time(s) are displayed on the web interface (Home page).

Retrieve shutdown times on the device:

Call up "Test/Simulation" -> "Test K1/K2" in the menu.

Start functions "Start Test K1" and/or "Start Test K1".

- If the system is switched on, this is switched off to measure a new release time.
- If the system is switched off, the release time of the last shutdown is displayed (Requirement: System was switched on once after the last device startup).

8.12 Relais K3

The relay K3 can be programmed to different functions (menu "Relay K3" -> "Relay function").

- Duration on
 - K3 switches on permanently after delay to K1+K2
 - Delay: Menu "Relay K3" -> "K3 to K1 + K2"
- Pulse on
 - K3 switches on for a pulse duration after delay to K1+K2
 - Delay: Menu "Relay K3" -> "K3 to K1 + K2"
 - Pulse duration: Menu "Relay K3" -> "K3 pulse"
- on in case of error.
 - on in case of error: K3 switches on in the event of an error on/in the device
- Life contact.
 - off in case of error: K3 switches off in the event of an error on/in the device
- Start signal
 - K3 switches on without delay ("Delayed Alarm on") when an alarm $U<$, $U<<$, $U>$, $U>>$, $f<$, $f<<$, $f>$ or $f>>$ is present
 - K3 switches off at a hysteresis of approx. 1 V from the alarm value (0.4 V when alarm value < 100 V)
- Release signal (Release signal, locked shutdown)
 - K3 switches on after a reset when K1 + K2 are on. The reset is done by the Up button (press 2s), or by a reset at the digital inputs In1...In3 (programmed).

8.13 Alarm counter

The alarm counter logs the number of alarms, total alarm time, alarm on and alarm off time, alarm cause, shutdown value and time of the last reset.

Up to 200 entries (100 alarms) are stored in a ring buffer.

All functions of the alarm counter can be easily used via the web interface ("Counter" page). The log is clearly displayed in a table and can be downloaded as a csv file.

On the device, you can access the functions or the log ("List") of the alarm counter via the "Counter" -> "Alarm" menu.

8.14 Standby statistics

In the standby statistics, the last 10 shutdowns are stored due to an event at the terminals E1-E2. The start and stop time of the incident, the number of events and the shutdown time are logged.

All functions of the standby statistics can be used and the log can be viewed on the web interface (page "Counter").

On the device, you can access the functions or the log ("list") of the "Standby statistics" via the menu "Counter" -> "Standby".

8.15 Relay counter

The number of switching procedures of the relays is recorded by two separate counters and stored in a non-volatile state on the device.

The first counter stores the switching procedures over the lifetime of the device.

The second counter stores switching procedures after a reset of the counter.

On the web interface (page "Counter"), all functions of the relay counter can be used and the counter readings can be viewed.

On the device, the functions and the "list" of the "relay counters" can be accessed via the menu "Counter" -> "Relay".

8.16 Firmware update

Firmware updates can be installed via the web browser ("System" page).

If update notifications are turned on, a message is displayed as soon as a new firmware version is available.

If the device is not connected to the Internet, the current firmware can be downloaded from www.ziehl.com

- Click "Select firmware" button
 - Select downloaded update file
- Click "Manual update installation"
 - Installing update

Afterwards the update file can be selected under (Manual installation -> Select firmware) and be executed via the button "Manual update installation".

If a firmware update fails, the device can be reset to the firmware version of the delivery.

- Switch off the device
- Keep the joystick button pressed down and switch on the device (keep holding the joystick button)
- After about 2 s, a blue screen will appear
- Briefly hold the joystick button upwards 3 times for 3 s
- Installing delivery firmware (this will take several minutes)

8.17 Program update

Using the button ("Check for updates...") on the "System" website, the website checks whether new/changed programs are available. If necessary, these can then be transferred to the device.

8.18 Protection test of UFR1002IP in connection with coupling device VG1200

If a voltage source with the required voltage levels is available, a protection test can be carried out on the devices in combination.

Alternatively, the UFR1002IP can be tested separately from the VG1200.

Testing UFR1002IP:

- disconnect the coupling device VG1200.
- Connect the grid simulator to the voltage inputs.
- The test is carried out with a reduced test voltage (calculation: voltage / factor)
Factors (transformation ratio) for the test voltages (L1-N, L2-N and L3-N for programmes with N connection, L1-L2, L2-L3 and L3-L1 for programmes without N connection) are displayed on the device in the "Info" -> "VG1200 factor" menu.
- Alternatively, a special mode can be activated for the protection test. Here the factor (transformation ratio) for the test voltage is fixed at 4.5 (all phases).
 - Activate protection test: Menu „Test/simulation“ -> „Protection test“ -> „start“
 - Protection testing is active for 15 minutes, „Protection / Testing“ flashes in the lower left display
 - Witch off the protection test manually: Menu „Test/simulation“ -> „Protection test“ -> „stop“

Note on the VG1200:

The resistance values of the lines L1-L1', L2-L2', L3-L3' and N-N' are 1800 kΩ (± 1,8 kΩ).

8.19 Suppress alarm U< function (U< inactive)

This function is only available in programs for VDE-AR-N 4110.

Setting on the device: Menu -> Digital Inputs -> E1-E2 -> Function: "U< inactive"

The "Alarm U<" function can be switched inactive via the digital input E1-E2 (configurable normally open/closed contact).

If this function is used in conjunction with the UFR1002IP as intermediate decoupling protection, the following must be observed:

- The alarm delay "Delayed alarm on" of the alarm U< must be less than that of the higher-level decoupling protection -> at least 50ms
- The alarm value of U< of the lower-level protection relays must be smaller than that of the higher-level protection relays to prevent unintentional triggering of the U< alarm (observe measurement tolerances of lower-level and higher-level protection relays)

9 Web interface

The integrated Ethernet interface offers further options for convenient programming, operation and measured value display.

The web browser of an web-enabled device takes you to the website of the device.

The following categories are available:

- Home
 - Display of status and measured values
 - Simulation of device functions
- Configuration
 - Program selection
 - Programming of the device functions
- System
 - System Information
 - Code lock
 - Firmware Updates
 - Program Updates
 - Backup and restore configurations
 - Factory reset and device restart
- Network
 - Network Settings
 - Date and time / time server
- User
 - User management
- Counter
 - Alarm counter
 - Standby statistics
 - Relay counter

9.1 Home

Display of

- system status (system on/off, error messages)
- current measured values with alarm status
- Min-Max- measured values (resettable)
- Program number of the set program
- Status relay states
- Status digital inputs
- Status feedback contacts with measured shutdown times (last shutdown)

Simulation of

- Measured values (voltage, frequency and vector shift)
- Relay

9.2 Configuration

Setting/viewing parameters for the device function

- Program
- Mains connection
- Connection conditions
- Reset conditions
- Alarm voltages
- Alarm frequency
- Frequency undervoltage protection
- Vector shift
- Rocof
- Feedback
- Relay K3
- Digital inputs

9.3 System

Setting/viewing of

- Display parameters
- Device name and commentary
- Firmware Updates
 - Update notification (message when update is available)
 - Firmware status, the firmware update can be carried out via the update button if necessary
 - Manual update installation:
 - Select firmware (select downloaded firmware)
 - Manual update installation (upload and install selected firmware)
- Program Updates
- Backup and restore configurations
- Factory reset (optionally with/without network parameters) and device restart

9.4 Network

Setting/viewing of

- network settings
- Modbus protocol (Modbus TCP, port 502)
- Time server settings and time zone settings
(for date/time in the device, important to be able to evaluate various counters in the device)

9.5 User

- User management (providing device with read and write permissions for users on the network)
- User (activate user and create name and password)
 - User name for guest upon login (fixed, cannot be changed): "guest", "Guest" or leave blank
- User permissions (determine which users have which rights on which pages)

Attention: Changes (also to passwords) are applied only after saving

(Save button)

9.5.1 User, admin forgot password

Disable user management on the device (sealing must be off, green lock on the display)

- Switch the device off and on again, keeping the joystick up button pressed (↑) until "Reset" appears on the display.
- Select user management and switch it off by pressing →

9.6 Counter

- Alarm counter (will be deleted when program is reassigned)
 - Storage of alarm events, with date/time, cause and shutdown value
 - Number and total alarm time
 - Logging of 200 shutdown and switch-on events
 - Resettable
 - List as csv download
- Standby statistics
 - Storage of standby events, with date/time
 - Number and standby time
 - Logging of the last 10 events
 - Resettable
- Relay counter
 - Total number
 - Number since last reset

10 Error search

In the event of a device error, an **Err** is displayed on the display pages and a „→“ indicates an error page. By pressing the joystick button to the right (→) , you can navigate to a fault description.

Error	Cause	Remedy
Measured value on the display shows EEE / -EE	Measured value is too large or too small	Check or remeasure the measured values. Observe measuring ranges.
Error message on the display: Error: Feedback	Error on the feedback contacts of the section switch (terminals Y0, Y1, Y2). Incorrect or implausible condition.	<u>No feedback contacts connected:</u> Program feedback, select "off" in the menu "Feedback" -> "Message on". <u>Feedback contact(s) connected:</u> - Check correct connection - Check plausibility of parameters in the "Feedback" menu ("Message to..." and "Time for message"). -> Perform reset: Press the joystick button ≥ 2 s upwards (↑).
Error message on the display: Error: Feedback off	Implausible state on the feedback contacts or shutdown time of the section switch > 0.5 s. (Terminals Y0, Y1, Y2).	Check feedback contacts on Y0-Y1 (Y0-Y2). Check the shutdown time(s) of the section switch (s) -> in the menu "Test/Simulation" -> "Test K1/K2"
Error message on the display: int. error slave 1 int. error slave 2 Error MA./slave 1 Error MA./slave 2 Error int. voltage	Internal device errors.	Switch the device off and on again (interrupt control voltage U_s for > 5 s).
Error in parameter alarm	Implausible alarm values are programmed.	Check parameters for alarm on and alarm off (all U and F alarms).
Parameter error	A parameter is out of its valid range	Load the reset programme Pr9.99. Then load the previously set programme again.
Internal memory error	Device internal memory error	Switch the device off and on again (interrupt control voltage U_s for > 5 s).
Invalid calibration values	Calibration error	Device is defective!
Parameter error	Invalid parameter	Switch the device off and on again (interrupt control voltage U_s for > 5 s).
Measurement tolerance error >>	Measured value deviation in the internal measuring channels too high	Switch the device off and on again (interrupt control voltage U_s for > 5 s).
Firmware version error	Incorrect/incompatible firmware versions installed	- Perform firmware update (only possible via web interface) - Reset firmware to delivery status -> 8.16 Firmware update
Code lock / User management	Forget Pin or Code	Switch the device off and on again, while holding the joystick button up (↑) until "Reset" appears on the display. Select the desired menu item and execute it.
Reset device to factory settings	Settings implausible	

11 Technical data

Control voltage Us	DC/AC 24 – 270 V	0/50/60 Hz
Tolerance	DC 20,4 - 297 V	AC 20 - 297 V
Power	< 4,5 W	< 12,5 VA
Bridging time at dropping	Us = AC 230 V → 0 V: 1,2 s	
Output relay K1, K2, K3	3 x change-over contact	
Switching voltage	max. AC 400 V; DC 300 V	
Switch-on current (NO)	25 A max. 4 s / 50 A max. 1 s 10% ED	
Min. voltage / current	12 V 10 mA	
Conventional thermal current I _{th}	6 A	
Switching power max. AC cos φ = 1	2400 VA	
Switching power max. DC (ohm)	0,3 A 300 V; 0,4 A 120 V; 0,8 A 60 V; 16 A 28 V	
Contact life electrical (IEC 61810)	16A, 250VAC, cosφ=1, 85°C 30x10 ³ 10A, 400VAC, cosφ=1, 85°C 150x10 ³	
Contact life mechanical	3 x 10 ⁷ operating cycles	
Utilization category Rated operational current	AC-15 I _e = 6 A U _e = 250 V	
Rated operational voltage	DC-13 I _e = 2 A U _e = 24 V	
	DC-13 I _e = 0,4 A U _e = 120 V	
	DC-13 I _e = 0,2 A U _e = 250 V	
Recommended fuse	gG/gL/B 6 A	
Voltage measurement		
Measurement voltage phase – phase	AC 15,0 ... 530,0 V	(<5 V -> display = 0)
Measurement voltage phase – N	AC 15,0 ... 310,0 V	(<5 V -> display = 0)
Adjustment range	AC 15,0 ... 520,0 V	
Measurement error	≤ 0,8% of the nominal voltage	
Measurement error at „Protection testing” in the programmes Pr2.xx	≤ 1% of the nominal voltage, at testing without VG1200 (with factor for voltages)	
Measurement functions	1 phase, 3 phase with/ without N	
Response time	adjustable, 0,05 ... 300,0 s (± 15 ms)	
Reset time	adjustable, 0 ... 6000 s (± 200 ms)	
input resistance phase-phase and phase-N	993 kΩ	
disengaging ratio	< 2 % (at values > 20 V)	
Frequency measurement		
Frequency range	40,00 ... 70,00 Hz	
Adjustment range	45,00 ... 65,00 Hz	
Measurement accuracy	± 0,05 Hz	
Response time	adjustable, 0,05 ... 300,0 s (± 15 ms)	
Reset time	adjustable, 0 ... 6000 s (± 200 ms)	
Frequency undervoltage protection (f/U<)	off / 10,0 ... 320,0 V	
disengaging ratio	< 1 %	
Zero voltage		
Measurement voltage phase – N	AC 0 ... 310 V	
Adjustment range	AC 1 ... 300 V	
Measurement principle	U ₀ is calculated from L1-N + L2-N + L3-N	
Measurement error	± 2,4% of the nominal voltage	
Response time	adjustable, 0,05 ... 300,0 s (± 15 ms)	
Reset time	adjustable, 0 ... 6000 s (± 200 ms)	

Vector shift	
Measurement range	0,0 ... 90,0 °
Adjustment range	2,0 ... 65,0 °
Response time	< 50 ms
Reset time	adjustable, 3 ... 240 s (± 200 ms)
Delay at Us on	adjustable, 2 ... 20 s (± 200 ms) (Suppression)
ROCOF (df/dt)	
Frequency range	40,00 Hz ... 70,00 Hz
Measurement error	± 0,05 Hz
Adjustment range	0,100 Hz/s ... 5,000 Hz/s und 4 ... 50 Periods
Response time	adjustable, 0,05 s ... 300,00 s (± 15 ms)
Reset time	adjustable, 0 s ... 6000 s (± 200 ms)
Measurement time	Number of adjusted Periods * Periods duration + Response time
Digital inputs +U-In1, +U-In2, +U-In3	
Connected cable length	for potential-free switching contacts max. 30 m
Connection	potential-free opener/closer contacts
Voltage / current	DC 15 ... 35 V / app. 4 mA
Reaction time	≤ 300 ms
Digital inputs Y0-Y1, Y0-Y2, E1-E2	
Connected cable length	Y0-Y1, Y0-Y2 -> Contactor feedback inputs max. 30 m
Connection	potential-free opener/closer contacts
Voltage / current Y0 – Y1 and Y0 – Y2 - Contactor response time	DC 15 ... 35 V / app. 4 mA 0,5 ... 990,0 s
Voltage / current E1 – E2	DC 15 ... 35 V / app. 6 mA
Switch-off time E1-E2 (until K1 + K2 off)	< 20 ms
Ethernet interface	
Speed	RJ45 connector 10 / 100 Mbit/s
Protocol	- http, Port 80 - Modbus TCP, Port 502, max. 3 connections
Real time clock	
Power reserve	> 11 days at 25°C
Time deviation	±3 ppm
Test conditions	
Rated impulse withstand voltage	IEC/EN 60255 4000 V
Overvoltage category	III
Pollutions degree	2
Rated insulation Ui	300 V
Operating time	100 %
EMC tests	
EMC emission	EN 60255-26 CISPR 11 class B
EMC immunity	EN 60255-26 industrial environment
Fast transient disturbances / Burst	EN 60255-26 ±4 kV Pulse 5/50 ns, f = 5 kHz, t = 15 ms, T = 300 ms
Surge immunity	EN 60255-26 ±2 kV
Electrostatic discharge	EN 60255-26 ± 6 kV contact discharge, ± 8 kV air discharge

Galvanic insulation (routine test)		EN 60255-27		
Relay K1		connection terminals:	12, 11, 14	
Relay K2		connection terminals:	22, 21, 24	
Relay K3		connection terminals:	32, 31, 34	
Control voltage Us		connection terminals:	A1, A2	
Measurement input [MeasIn]		connection terminals:	L1, L2, L3, N, E1, E2, Y0, Y1, Y2	
Digital Inputs [DIn]		connection terminals:	+U, In1, In2, In3	
Ethernet [Eth]		connection terminals:	Ethernet socket (all pins)	
K1 → K3		basic insulation,	test voltage DC 3820 V	
K1, K3 → MeasIn, Eth, Us		reinforced insulation,	test voltage DC 3820 V	
K2 → K1, K3, MeasIn, DIn, Eth, Us		reinforced insulation,	test voltage DC 3820 V	
Us → MeasIn, DIn, Eth, K1, K3		reinforced insulation,	test voltage DC 3820 V	
MeasIn → DIn, Eth		reinforced insulation,	test voltage DC 3820 V	
DIn → Eth			test voltage DC 700 V	
Information according to 60255-1:2010				
Max. inrush current		< 30 A (source impedance app. 0,01 Ω)		
Load idle at Us		< 2,9 VA at AC 24 V, < 8,5 VA at AC 270 V < 1,8 W at DC 24 V, < 1,8 W at DC 270 V		
Maximum load at Us		< 5,5 VA at AC 24 V, < 11,3 VA at AC 270 V < 3,7 W at DC 24 V, < 3,3 W at DC 270 V		
Inrush current at Us		app. 3 A at AC 24 V (source impedance app. 0,1 Ω) app. 29 A at AC 270 V (source imped. app. 0,01 Ω) app. 2,4 A at AC 24 V (source imped. app. 0,17 Ω) app. 28 A at AC 270 V (source imped. app. 0,018Ω)		
Inrush time with higher current		< 60 ms (Us = AC), < 10 ms (Us = DC)		
Installation conditions				
Permissible ambient temperature		-20 °C ... +55 °C		
Permissible storage temperature		-20 °C ... +70 °C		
Installation height		< 2000 m over N.N.		
Climatic conditions		5-85% rel. F., no condensation		
Permissible wiring temperature		-5 °C ... +70 °C		
Vibration		IEC 60255-21-1	class 1	
Shock		IEC 60255-21-2	class 1	
Seismic test		IEC 60255-21-3	class 1	
Reliability – failure rate		EN 61709/ SN29500		
Ambient conditions		local operation in dry rooms		
Operation time 24/365		8760 h/a		
Failure rate (FIT)		Tu = 40 °C	Tu = 60°C	Tu = 80°C
Tu = Tref (component not in operation)		2323 FIT	4537 FIT	9734 FIT
		49 years	25 years	11,7 years
Housing		Construction form V6, Distribution panel		
Dimensions (W x H x D)		105 x 90 x 69 mm		
Front-to-back size		55 mm		
Protection class housing		IP30		
Mounting		Snap mounting on 35 mm standard rail EN60715 or M4 screws (additional bar not included)		
Weight		app. 290 g		

Connection terminals

Line connection solid wire

1 x 0,34 - 2,5 mm² / AWG 22 - 12

Flexible with ferrule

1 x 0,1 - 1,5 mm² / AWG 27 - 14

Stripping length / specify torque

8 mm / 0,5 Nm

Protection class, connection terminals

IP20

Connection terminals L1, L2, L3, N

Line connection solid wire

1 x 0,34 - 4,0 mm² / AWG 22 - 12

Line connection stranded wire

1 x 0,34 - 4,0 mm² / AWG 22 - 12

Stripping length / specify torque

8 mm / 0,5 Nm

Protection class, connection terminals

IP20

Subject to technical changes

12 Housing Type V6

Dimensions in mm

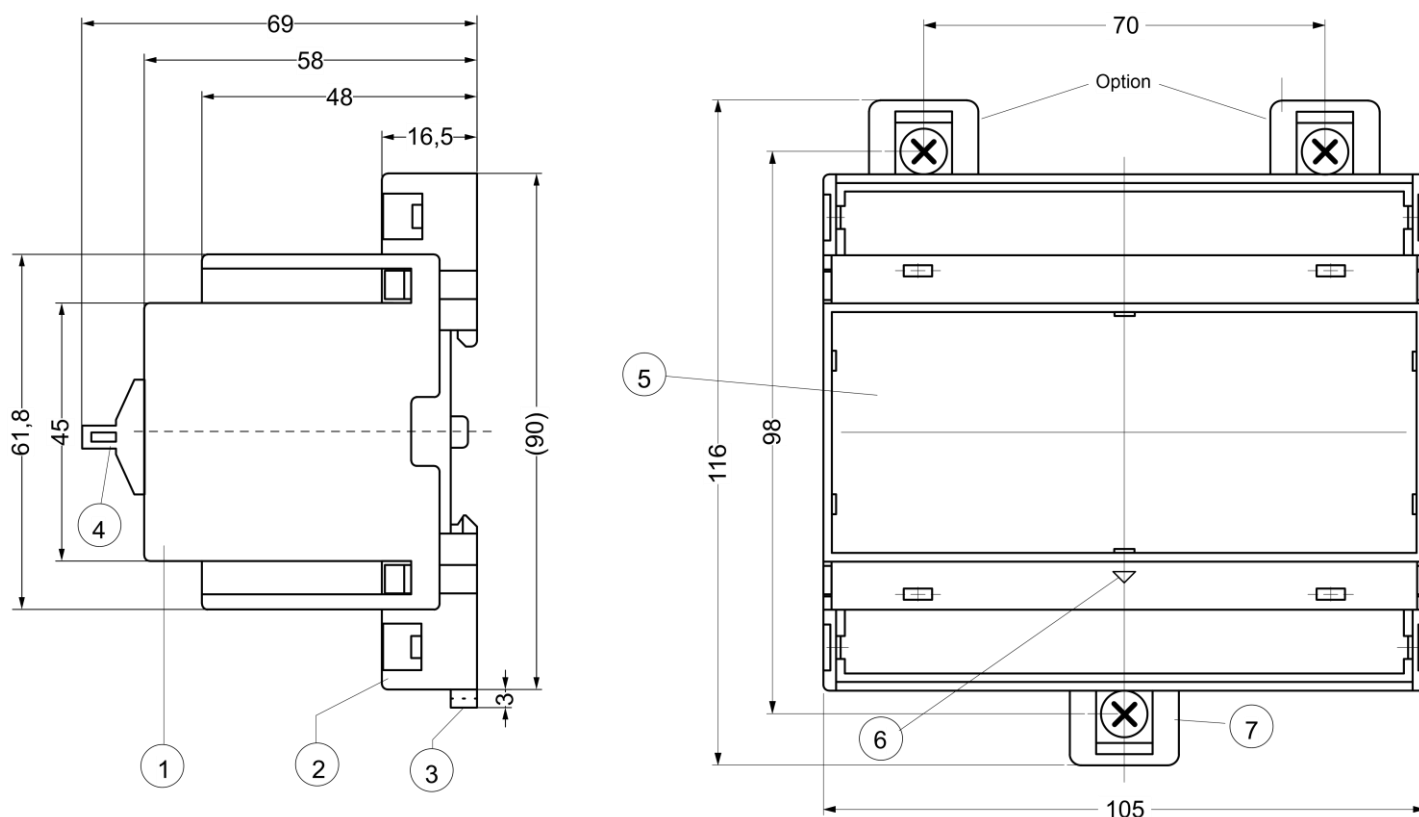

- 1 Oberteil / cover
- 2 Unterteil / base
- 3 Riegel / bar for snap mounting
- 4 Plombierung max. Ø 1,5 mm / sealing max. Ø 1,5 mm
- 5 Frontplatteneinsatz / front panel
- 6 Kennzeichen für unten / position downward
- 7 Riegel bei Wandbefestigung mit Schrauben. Riegelbohrung Ø 4,2 mm / for fixing to wall with screws, Ø 4,2 mm

13 Disposal



Disposal should be carried out properly and in an environmentally friendly manner in accordance with legal provisions.

ZIEHL is registered with the EAR Foundation under WEEE no.: DE 49 698 543.

14 Adjustment values according to VDE and BDEW

14.1 VDE-AR-N 4105:2011, Section 6.5.2, Low Voltage – Pr1.01 + Pr1.07

Protective function	AR 4105	in * Un	in % Un	Adjustment value	Tripping time Delay alarm on	OFF-delay Delay alarm off
Voltage decrease protection	U <	0,8 * Un	80 % Un	184 V	100 ms	60 s
Voltage increase protection (10-minutes mean value)	U >	1,1 * Un	110 % Un	253 V	100 ms	60 s
Voltage increase protection	U >>	1,15 * Un	115 % Un	264 V	100 ms	60 s
Frequency decrease protection	f <			47,5 Hz	100 ms	60 s
Frequency increase protection	f >			51,5 Hz	100 ms	60 s
Switching conditions after alarms				triggered		

14.2 BDEW June 2008, acc. 3.2.3.3-1, Medium Voltage – Pr1.03 ... Pr1.06

Funktion	BDEW	Adjustment range of the protective relay	Default settings	
Voltage increase protection	U >>	1,00 – 1,30 Un	1,15 Un	100 ms
Voltage increase protection	U >	1,00 – 1,30 Un	1,08 Un	60 s
Voltage decrease protection	U <	0,10 – 1,00 Un	0,80 Un	2,7 s
Voltage decrease protection *	U <<	0,10 – 1,00 Un	0,45 Un	300 ms
Frequency increase protection	f >	50,0 – 65,0 Hz	51,5 Hz	100 ms
Frequency decrease protection	f <	45,0 – 50,0 Hz	47,5 Hz	100 ms
Switching conditions after alarms			triggered	

- * Not enabled in as delivered condition
- Reset time "Delay alarm off" for all limit values set ex works: 60 s

14.3 VDE-AR-N 4105:2018-11 Low Voltage, acc. 6. table 2 – Pr1.02

Adjustment values for converters

Protective function	AR-N 4105	in * Un	in % Un	Adjustment value	Tripping time Delay alarm on	OFF-delay Delay alarm off
Voltage increase protection	U >>	1,25 * Un	125 % Un	287,5 V	100 ms	60 s
Voltage increase protection (10-minutes mean value)	U >	1,1 * Un	110 % Un	253 V	100 ms	60 s
Voltage decrease protection	U <	0,8 * Un	80 % Un	184 V	3,0 s	60 s
Voltage decrease protection	U <<	0,45 * Un	45 % Un	103,5 V	300 ms	60 s
Frequency increase protection	f >			51,5 Hz	100 ms	60 s
Frequency decrease protection	f <			47,5 Hz	100 ms	60 s
Switching conditions after alarms				triggered		

14.4 VDE-AR-N 4110:2018-11 + 4110:2023-09 Medium Voltage

**Higher Protection,
use only if no QU protection is required and agreed with network operator or certifier.**

Programs : Pr1.11 Pr1.12

Acc. to 10.3.5.3 table 12, higher protection device

Function	AR-N 4110	Adjustment range of the protective relay	Default settings	
Voltage increase protection	$U \gg$	1,00 – 1,30 U_n	1,2 U_n	300 ms
Voltage increase protection	$U >$	1,00 – 1,30 U_n	1,1 U_n	180 s
Voltage decrease protection	$U <$	0,10 – 1,00 U_n	0,80 U_n	2,7 s
Frequency increase protection *	$f >$	50,0 – 65,0 Hz	51,5 Hz	5,4 s
Frequency decrease protection *	$f <$	45,0 – 50,0 Hz	47,5 Hz	400 ms
Switching conditions after alarms			triggered	

- * Not enabled in as delivered condition

14.5 VDE-AR-N 4110:2018-11 + 4110:2023-09 Medium Voltage, Unit Protection Pr 1.13 + 1.14

Intermediate decoupling protection on the generation units

Programs : Pr1.13 Pr1.14 Pr2.00 Pr2.01 Pr2.02 Pr2.10 Pr2.11

Acc. to 10.3.5.3 table 13

Function	AR-N 4110	Adjustment range of the protective relay	Default settings	
Voltage increase protection	$U \gg$	1,00 – 1,30 U_n	1,25 U_n	100 ms
Voltage decrease protection	$U <$	0,15 – 1,00 U_n	0,80 U_n	1,0 s
Voltage decrease protection	$U \ll$	0,10 – 1,00 U_n	0,45 U_n	300 ms
Frequency increase protection	$f \gg$	50,0 – 65,0 Hz	52,5 Hz	100 ms
Frequency increase protection	$f >$	50,0 – 65,0 Hz	51,5 Hz	5,0 s
Frequency decrease protection	$f <$	45,0 – 50,0 Hz	47,5 Hz	100 ms
Switching conditions after alarms			all F + $U <$ + $U \ll$	

After startup and (if necessary) protection testing, the times for the switch-on delay ("Delay alarm off") must be checked and set according to the network operator's specifications.

Setting for all alarms U and F Alarms together in the menu item "Test/Simulation" -> "Switch back time" (Reset time).

14.6 VDE-AR-N 4120:2018-11 High voltage, Unit Protection

Programs :	Pr1.66	Pr1.67	Pr1.68	Pr1.69	Pr2.30	Pr2.31	Pr2.32
-------------------	--------	--------	--------	--------	--------	--------	--------

According to Table 8 from VDE-AR-N 4120:2018-11:

Function		Adjustment range of the protective relay	Default settings	
Voltage decrease protection	U <	0,10 – 1,00 U _n	0,80 U _n	2,4 s
Voltage decrease protection	U <<	0,10 – 1,00 U _n	0,30 U _n	800 ms
Voltage increase protection	U >>	1,00 – 1,30 U _n	1,25 U _n	100 ms
Frequency increase protection	f >	50,0 – 65,0 Hz	51,5 Hz	≤ 5 s
Frequency increase protection	f >>	50,0 – 65,0 Hz	52,5 Hz	≤ 100 ms
Frequency decrease protection	f <	45,0 – 50,0 Hz	47,5 Hz	≤ 100 ms
Switching conditions after alarms			all f + U < + U <<	

After startup and (if necessary) protection testing, the times for the switch-on delay ("Delay alarm off") must be checked and set according to the network operator's specifications.

Setting for all alarms U and F Alarms together in the menu item "Test/Simulation" -> "Switch back time" (Reset time).

14.7 VDE-AR-N 4130:2018-11 Maximum voltage, Unit Protection

Programs :	Pr1.60	Pr1.61	Pr1.62	Pr1.63	Pr2.20	Pr2.21	Pr2.22
-------------------	--------	--------	--------	--------	--------	--------	--------

According to E.7 from VDE-AR-N 4130:2018-11 (point 2 -> 2.1)

Function			Default settings	
Voltage increase protection	U >>		1,25 U _n	100 ms
Voltage decrease protection	U <		0,8 U _n	3 s
Voltage decrease protection	U <<		0,3 U _n	1,5 s
Frequency increase protection	f >>		52,5 Hz	≤ 100 ms
Frequency decrease protection	f <		47,5 Hz	≤ 100 ms
Switching conditions after alarms			all f + U < + U <<	

After startup and (if necessary) protection testing, the times for the switch-on delay ("Delay alarm off") must be checked and set according to the network operator's specifications.

Setting for all alarms U and F Alarms together in the menu item "Test/Simulation" -> "Switch back time" (Reset time).

15 Default settings of the programs

15.1 VDE-AR-N 4105:2011+2018

When changing the program, all parameters are reset.

pre-set at factory

Main menu	Sub menu	Parameter menu	My Data	Germany  VDE-AR-N4105:		Generator, Pn		EAAV ≤ 500 kW 3AC + 3AC+N 230 V	
				2011 3AC + 3AC+N 230 V	2018 3AC + 3AC+N 230 V	≤ 50 kW 3AC + 3AC+N 230 V	> 50 kW 3AC + 3AC+N 230 V		
				Pr1.01 Ver. 00	Pr1.07 Ver. 00	Pr1.02 Ver. 00	Pr1.08 Ver. 00	Pr1.09 Ver. 00	Pr1.17 Ver. 00
Mains connection		Connection		3AC-N / 3AC	1AC-N	3AC-N / 3AC	3AC-N / 3AC	3AC-N / 3AC	3AC-N / 3AC
		Nominal voltage [V]		230,0	230,0	230,0	230,0	230,0	230,0
		Coupling device		no	no	no	no	no	no
Switch on conditions	Voltage	Active		no	no	no	no	no	no
		U max. [V]		259,0	259,0	252,5	252,5	252,5	253,0
		U min. [V]		189,0	189,0	196,0	196,0	196,0	195,5
	Frequency	Active		no	no	no	no	no	no
		F max. [Hz]		50,05	50,05	50,10	50,10	50,10	50,10
		F min. [Hz]		48,50	48,50	47,60	47,60	47,60	47,60
	Switch on delay	Time [s]		60	60	60	60	60	60
After alarms	Switch back		triggered	triggered	triggered	triggered	triggered	triggered	
Short alarm	Active		yes	yes					
Voltage	U >> 59.S2 59>S2	Alarm active				yes	yes	yes	yes
		Alarm on [V]				287,5	264,5	287,5	287,5
		Alarm off [V]				252,5	252,5	252,5	253,0
		Delay alarm on [s]				0,10	0,10	0,10	0,10
		Delay alarm off [s]				60	60	60	60
	U > 59.S1 59>S1	Alarm active		yes	yes	no	no	no	no
		Alarm on [V]		264,0	264,0	264,0	264,0	264,0	264,0
		Alarm off [V]		259,0	259,0	252,0	252,0	252,0	252,0
		Delay alarm on [s]		0,10	0,10	0,10	0,10	0,10	0,10
		Delay alarm off [s]		60	60	60	60	60	60
	UM> 59-Av	Alarm active		yes	yes	yes	yes	yes	yes
		Alarm on [V]		253,0	253,0	253,0	253,0	253,0	253,0
		Alarm off [V]		250,0	250,0	248,0	248,0	248,0	248,0
		Delay alarm on [s]		0,10	0,10	0,10	0,10	0,10	0,10
		Delay alarm off [s]		60	60	60	60	60	60
	U < 27.S1 27<S1	Alarm active		yes	yes	yes	yes	yes	yes
		Alarm on [V]		184,0	184,0	184,0	184,0	184,0	184,0
		Alarm off [V]		189,0	189,0	196,0	196,0	196,0	195,5
		Delay alarm on [s]		0,10	0,10	3,00	0,10	1,00	3,00
		Delay alarm off [s]		60	60	60	60	60	60
U << 27.S2 27<S2	Alarm active				yes	no	yes	yes	
	Alarm on [V]				103,5	103,5	103,5	103,5	
	Alarm off [V]				196,5	196,5	196,5	195,5	
	Delay alarm on [s]				0,30	0,30	0,30	0,30	
	Delay alarm off [s]				60	60	60	60	

Pr1.02:

- set ex works

Pr1.02, Pr1.08, Pr1.09, Pr1.17:

- Code lock ex works activated

- Blue values -> parameters that can be changed with code lock

Grey values can only be read (not changed) regardless of the code lock/sealing.

Main menu	Sub menu	Parameter menu	My Data	Germany VDE-AR-N4105: 			Generator, Pn		EAAV	
				2011		2018	≤ 50 kW	> 50 kW	≤ 500 kW	
				3AC + 3AC+N 230 V	1AC+N 230 V	3AC + 3AC+N 230 V	3AC + 3AC+N 230 V	3AC + 3AC+N 230 V	3AC + 3AC+N 230 V	
			Pr1.01 Ver. 00	Pr1.07 Ver. 00	Pr1.02 Ver. 00	Pr1.08 Ver. 00	Pr1.09 Ver. 00	Pr1.17 Ver. 00		
	U0 59v0	Alarm active		no		no	no	no	no	
		Alarm on [V]		46,0		46,0	46,0	46,0	46,0	
		Alarm off [V]		36,0		36,0	36,0	36,0	36,0	
		Delay alarm on [s]		1,50		1,50	1,50	1,50	1,50	
		Delay alarm off [s]		60		60	60	60	60	
		Display U0/UM> [s]		5,0		5,0	5,0	5,0	5,0	
Frequency	f >> 81.S2 81>S2	Alarm active				no	no	no	yes	
		Alarm on [Hz]				52,50	52,50	52,50	52,50	
		Alarm off [Hz]				50,10	50,10	50,10	50,10	
		Delay alarm on [s]				0,10	0,10	0,10	0,10	
		Delay alarm off [s]				60	60	60	60	
	f > 81.S1 81>S1	Alarm active		yes	yes	yes	yes	yes	yes	yes
		Alarm on Hz		51,50	51,50	51,50	51,50	51,50	51,50	51,50
		Alarm off Hz		50,05	50,05	50,10	50,10	50,10	50,10	50,10
		Delay alarm on [s]		0,10	0,10	0,10	0,10	0,10	0,10	5,00
		Delay alarm off [s]		60	60	60	60	60	60	60
	f < 81.S1 81<S1	Alarm active		yes	yes	yes	yes	yes	yes	yes
		Alarm on [Hz]		47,50	47,50	47,50	47,50	47,50	47,50	47,50
		Alarm off [Hz]		48,50	48,50	47,60	47,60	47,60	47,60	47,60
		Delay alarm on [s]		0,10	0,10	0,10	0,10	0,10	0,10	0,10
		Delay alarm off [s]		60	60	60	60	60	60	60
	f << 81.S2 81<S2	Alarm active					no	no	no	no
		Alarm on [Hz]					47,00	47,00	47,00	47,00
		Alarm off [Hz]					47,60	47,60	47,60	47,60
Delay alarm on [s]						0,10	0,10	0,10	0,10	
Delay alarm off [s]						60	60	60	60	
f/U< protect	Alarm active					no	no	no	no	
		U< Limit [V]		46,0	46,0	46,0	46,0	46,0	46,0	46,0
	Frequency-range	Alarm active								
		Alarm U< on [V]								
		Alarm U< off [V]								
		Alarm 3U0 on [V]								
		Alarm 3U0 off [V]								
		Delay alarm on [s]								
	Delay alarm off [s]									
	Vector shift	Alarm active		no	no	no	no	no	no	no
		VSR deg °		10,0	10,0	10,0	10,0	10,0	10,0	10,0
		Delay alarm off [s]		3	3	3	3	3	3	3
suppression [s]			2	2	2	2	2	2	2	
ROCOF	Alarm active		no	no	no	no	no	no	no	
	df / dt		0,800	0,800	2,000	2,000	2,000	2,000	2,000	
	Periods		20	20	20	20	20	20	20	
	Delay alarm on [s]		0,10	0,10	0,10	0,10	0,10	0,10	0,10	
	Delay alarm off [s]		60	60	60	60	60	60	60	
Feed-back	Feedback at		Y1+Y2	Y1+Y2	Y1	Y1	Y1	Y1	Y1	
	Time for feedb. [s]		5,0	5,0	5,0	5,0	5,0	5,0	5,0	
	Reclosing attempts		2	2	2	2	2	2	2	
	Reclosing Time [s]		5	5	5	5	5	5	5	

Pr1.02, Pr1.08, Pr1.09, Pr1.17: - Code lock ex works activated
- Blue values -> parameters that can be changed with code lock

Main menu	Sub menu	Parameter menu	My Data	Germany  VDE-AR-N4105:			Generator, Pn		EAAV
				2011		2018	≤ 50 kW	> 50 kW	≤ 500 kW
				3AC + 3AC+N 230 V	1AC+N 230 V	3AC + 3AC+N 230 V	3AC + 3AC+N 230 V	3AC + 3AC+N 230 V	3AC + 3AC+N 230 V
				Pr1.01 Ver. 00	Pr1.07 Ver. 00	Pr1.02 Ver. 00	Pr1.08 Ver. 00	Pr1.09 Ver. 00	Pr1.17 Ver. 00
Relay K3		Relay function		life-contact	life-contact	life-contact	life-contact	life-contact	life-contact
		K3 pulse [s]		2,0	2,0	2,0	2,0	2,0	2,0
		K3 after K1+K2 [s]		0,1	0,1	0,1	0,1	0,1	0,1
Digital Inputs	E1-E2	Type		normally open	normally open	normally open	normally open	normally open	normally open
		Function		System off	System off	System off	System off	System off	System off
	In1	Type		normally open	normally open	normally open	normally open	normally open	normally open
		Function		Y1 inactive	Y1 inactive	Y1 inactive	Y1 inactive	Y1 inactive	Y1 inactive
		Sw.-on delay [s]							
	In2	Type		normally open	normally open	normally open	normally open	normally open	normally open
		Function		Y2 inactive	Y2 inactive	Y2 inactive	Y2 inactive	Y2 inactive	Y2 inactive
		Sw.-on delay [s]							
	In3	Type		normally open	normally open	normally open	normally open	normally open	normally open
		Function		Y1+Y2 inactive	Y1+Y2 inactive	Y1+Y2 inactive	Y1+Y2 inactive	Y1+Y2 inactive	Y1+Y2 inactive
		Sw.-on delay [s]							
	Network		Network						
		DHCP							
		IP address							
		Subnet mask							
		Gateway							
		DNS server							
		MAC address							
Settings		Language							
		Date							
		Time							
		Display interval [s]		0,5	0,5	0,5	0,5	0,5	0,5
		Brightness [%]		50	50	50	50	50	50
		Dimming time [s]		300	300	300	300	300	300
		Factory setting		-	-	-	-	-	-
		Restart		-	-	-	-	-	-
		Code lock / Pin		off / 504	off / 504	on / 504	on / 504	on / 504	on / 504
Test/simulation		Relay							
		Simulation							
		Test K1/K2							
		switch back time [s]		60	60	60	60	60	60
Info		Firmware version							
		Serial number							
		Operating hours							
		Comment							

- Pr1.02, Pr1.08, Pr1.09, Pr1.17: - Code lock ex works activated
- Blue values -> parameters that can be changed with code lock
- Orange values -> only visible, if „function“ = „DI Release“ is set

Main menu	Sub menu	Parameter menu	My Data	Germany VDE-AR-N4105: 		Generator, Pn		EAAV
				2011	2018	≤ 50 kW	> 50 kW	≤ 500 kW
				3AC + 3AC+N 230 V	1AC+N 230 V	3AC + 3AC+N 230 V	3AC + 3AC+N 230 V	3AC + 3AC+N 230 V
				Pr1.01 <i>Ver. 00</i>	Pr1.07 <i>Ver. 00</i>	Pr1.02 <i>Ver. 00</i>	Pr1.08 <i>Ver. 00</i>	Pr1.09 <i>Ver. 00</i>
								Pr1.17 <i>Ver. 00</i>
Counter	Alarm	Last reset						
		Number						
		List						
		Time sum						
		Reset						
	Standby	Last reset						
		Number						
		List						
		Time sum						
		Reset						
	Relay	Last reset						
		List						
		Reset						

Pr1.02, Pr1.08, Pr1.09, Pr1.17: - Code lock ex works activated
- Blue values -> parameters that can be changed with code lock

15.2 BDEW

When changing the program, all parameters are reset.

Main menu	Sub menu	Parameter menu	My Data	 Germany BDEW			
				3AC+N 57,7 V Pr1.03 Ver. 00	3AC 100 V Pr1.04 Ver. 00	3AC+N 230 V Pr1.05 Ver. 00	3AC 400 V Pr1.06 Ver. 00
Mains connection		Connection		3AC-N	3AC	3AC-N	3AC
		Nominal voltage [V]		57,7	100,0	230,0	400,0
		Coupling device		no	no	no	no
Switch on conditions	Voltage	Active		no	no	no	no
		U max. [V]		61,3	107,0	246,0	427,0
		U min. [V]		47,2	81,0	187,0	321,0
	Frequency	Active		no	no	no	no
		F max. [Hz]		50,05	50,05	50,05	50,05
		F min. [Hz]		48,50	48,50	48,50	48,50
	Switch on delay	Time [s]		60	60	60	60
	After alarms	Switch back		triggered	triggered	triggered	triggered
Short alarm	Active						
Voltage	U >> 59.S2	Alarm active		yes	yes	yes	yes
		Alarm on [V]		66,4	115,0	264,0	458,0
		Alarm off [V]		65,4	114,0	261,0	455,0
		Delay alarm on [s]		0,10	0,10	0,10	0,10
		Delay alarm off [s]		60	60	60	60
	U > 59.S1	Alarm active		yes	yes	yes	yes
		Alarm on [V]		62,3	108,0	249,0	430,0
		Alarm off [V]		61,3	107,0	246,0	427,0
		Delay alarm on [s]		60,00	60,00	60,00	60,00
		Delay alarm off [s]		60	60	60	60
	UM> 59-Av	Alarm active		no	no	no	no
		Alarm on [V]		63,5	110,0	253,0	438,0
		Alarm off [V]		62,5	109,0	250,0	435,0
		Delay alarm on [s]		0,10	0,10	0,10	0,10
		Delay alarm off [s]		60	60	60	60
	U < 27.S1	Alarm active		yes	yes	yes	yes
		Alarm on [V]		46,2	80,0	184,0	318,0
		Alarm off [V]		47,2	81,0	187,0	321,0
		Delay alarm on [s]		2,70	2,70	2,70	2,70
		Delay alarm off [s]		60	60	60	60
	U << 27.S2	Alarm active		no	no	no	no
		Alarm on [V]		26,0	45,0	104,0	180,0
		Alarm off [V]		27,0	46,0	106,0	182,0
		Delay alarm on [s]		0,30	0,30	0,30	0,30
Delay alarm off [s]			60	60	60	60	

Grey values can only be read (not changed) regardless of the code lock/sealing.

Main menu	Sub menu	Parameter menu	My Data	 Germany BDEW				
				3AC+N 57,7 V	3AC 100 V	3AC+N 230 V	3AC 400 V	
				Pr1.03 Ver. 00	Pr1.04 Ver. 00	Pr1.05 Ver. 00	Pr1.06 Ver. 00	
	U0 59v0	Alarm active		no	no	no	no	
		Alarm on [V]		46,0	80,0	46,0	80,0	
		Alarm off [V]		36,0	70,0	36,0	70,0	
		Delay alarm on [s]		1,50	1,50	1,50	1,50	
		Delay alarm off [s]		60	60	60	60	
		Display U0/UM> [s]		5,0	5,0	5,0	5,0	
Frequency	f >> 81.S2 81>S2	Alarm active		no	no	no	no	
		Alarm on [Hz]		51,50	51,50	51,50	51,50	
		Alarm off [Hz]		50,05	50,05	50,05	50,05	
		Delay alarm on [s]		0,10	0,10	0,10	0,10	
		Delay alarm off [s]		60	60	60	60	
	f > 81.S1 81>S1	Alarm active		yes	yes	yes	yes	
		Alarm on Hz		51,50	51,50	51,50	51,50	
		Alarm off Hz		50,05	50,05	50,05	50,05	
		Delay alarm on [s]		0,10	0,10	0,10	0,10	
		Delay alarm off [s]		60	60	60	60	
	f < 81.S1 81<S1	Alarm active		yes	yes	yes	yes	
		Alarm on [Hz]		47,50	47,50	47,50	47,50	
		Alarm off [Hz]		48,50	48,50	48,50	48,50	
		Delay alarm on [s]		0,10	0,10	0,10	0,10	
		Delay alarm off [s]		60	60	60	60	
	f << 81.S2 81<S2	Alarm active		no	no	no	no	
		Alarm on [Hz]		47,50	47,50	47,50	47,50	
		Alarm off [Hz]		48,50	48,50	48,50	48,50	
		Delay alarm on [s]		0,10	0,10	0,10	0,10	
		Delay alarm off [s]		60	60	60	60	
f/U< protect Frequency-range	f/U< protect	Alarm active		no	no	no	no	
		U< Limit [V]		20,0	20,0	46,0	46,0	
	Frequency-range	Alarm active						
		Alarm U< on [V]						
		Alarm U< off [V]						
		Alarm 3U0 on [V]						
		Alarm 3U0 off [V]						
		Delay alarm on [s]						
		Delay alarm off [s]						
	Vector shift		Alarm active		no	no	no	no
			VSR deg °		10,0	10,0	10,0	10,0
			Delay alarm off [s]		3	3	3	3
			suppression [s]		3	3	3	3
ROCOF		Alarm active		no	no	no	no	
		df / dt		0,800	0,800	0,800	0,800	
		Periods		20	20	20	20	
		Delay alarm on [s]		0,10	0,10	0,10	0,10	
		Delay alarm off [s]		60	60	60	60	
Feed-back		Feedback at		off	off	off	off	
		Time for feedb. [s]		1,5	1,5	1,5	1,5	
		Reclosing attempts		2	2	2	2	
		Reclosing Time [s]		5	5	5	5	

Main menu	Sub menu	Parameter menu	My Data	 Germany BDEW			
				3AC+N 57,7 V	3AC 100 V	3AC+N 230 V	3AC 400 V
				Pr1.03 Ver. 00	Pr1.04 Ver. 00	Pr1.05 Ver. 00	Pr1.06 Ver. 00
Relay K3		Relay function		life- contact	life- contact	life- contact	life- contact
		K3 pulse [s]		2,0	2,0	2,0	2,0
		K3 after K1+K2 [s]		0,1	0,1	0,1	0,1
Digital Inputs	E1-E2	Type		normally open	normally open	normally open	normally open
		Function		System off	System off	System off	System off
	In1	Type		normally open	normally open	normally open	normally open
		Function		Y1 inactive	Y1 inactive	Y1 inactive	Y1 inactive
		Sw.-on delay [s]					
	In2	Type		normally open	normally open	normally open	normally open
		Function		Y2 inactive	Y2 inactive	Y2 inactive	Y2 inactive
		Sw.-on delay [s]					
	In3	Type		normally open	normally open	normally open	normally open
		Function		Y1+Y2 inactive	Y1+Y2 inactive	Y1+Y2 inactive	Y1+Y2 inactive
		Sw.-on delay [s]					
	Network		Network				
		DHCP					
		IP address					
		Subnet mask					
		Gateway					
		DNS server					
		MAC address					
Settings		Language					
		Date					
		Time					
		Display interval [s]		0,5	0,5	0,5	0,5
		Brightness [%]		50	50	50	50
		Dimming time [s]		300	300	300	300
		Factory setting		-	-	-	-
		Restart		-	-	-	-
	Code lock / Pin		off / 504	off / 504	off / 504	off / 504	
Test/ simula- tion		Relay					
		Simulation					
		Test K1/K2					
		switch back time [s]		60	60	60	60
Info		Firmware version					
		Serial number					
		Operating hours					
		Comment					

- Orange values -> only visible, if „function“ = „DI Release“ is set

Main menu	Sub menu	Parameter menu	My Data	 Germany BDEW			
				3AC+N 57,7 V Pr1.03 Ver. 00	3AC 100 V Pr1.04 Ver. 00	3AC+N 230 V Pr1.05 Ver. 00	3AC 400 V Pr1.06 Ver. 00
Counter	Alarm	Last reset					
		Number					
		List					
		Time sum					
		Reset					
	Standby	Last reset					
		Number					
		List					
		Time sum					
		Reset					
	Relay	Last reset					
		List					
Reset							

15.3 VDE-AR-N 4110:2018-11 + VDE-AR-N 4110:2023-09

When changing the program, all parameters are reset.

Main menu	Sub menu	Parameter menu	My Data	 Germany VDE-AR-N 4110:2018 + VDE-AR-N 4110:2023			
				3AC+N 57,7 V Pr1.11 Ver. 02	3AC 100 V Pr1.12 Ver. 02	3AC+N 230 V Pr1.13 Ver. 02	3AC 400 V Pr1.14 Ver. 02
Mains connection		Connection		3AC-N	3AC	3AC-N	3AC
		Nominal voltage [V]		57,7	100,0	230,0	400,0
		Coupling device		no	no	no	no
Switch on conditions	Voltage	Active		no	no	yes	yes
		U max. [V]		63,5	110,0	253,0	440,0
		U min. [V]		51,9	90,0	207,0	360,0
	Frequency	Active		no	no	yes	yes
		F max. [Hz]		50,20	50,20	50,20	50,20
		F min. [Hz]		47,50	47,50	47,50	47,50
	Switch on delay	Time [s]		60	60	60	60
	After alarms	Switch back		triggered	triggered	all F+U<+U<<	all F+U<+U<<
Short alarm	Active						
Voltage	U >> 59.S2 59>S2	Alarm active		yes	yes	yes	yes
		Alarm on [V]		69,2	120,0	287,0	498,0
		Alarm off [V]		68,2	119,0	284,0	495,0
		Delay alarm on [s]		0,30	0,30	0,10	0,10
		Delay alarm off [s]		60	60	60	60
	U > 59.S1 59>S1	Alarm active		yes	yes	no	no
		Alarm on [V]		63,5	110,0	249,0	430,0
		Alarm off [V]		62,5	109,0	246,0	427,0
		Delay alarm on [s]		180,00	180,00	60,00	60,00
		Delay alarm off [s]		60	60	60	60
	UM> 59-Av	Alarm active		no	no	no	no
		Alarm on [V]		63,5	110,0	253,0	438,0
		Alarm off [V]		62,5	109,0	250,0	435,0
		Delay alarm on [s]		0,10	0,10	0,10	0,10
		Delay alarm off [s]		60	60	60	60
	U < 27.S1 27<S1	Alarm active		yes	yes	yes	yes
		Alarm on [V]		46,2	80,0	184,0	318,0
		Alarm off [V]		55,2	95,5	219,0	379,0
		Delay alarm on [s]		2,70	2,70	1,00	1,00
		Delay alarm off [s]		60	60	60	60
U << 27.S2 27<S2	Alarm active		no	no	yes	yes	
	Alarm on [V]		26,0	45,0	104,0	179,0	
	Alarm off [V]		55,0	95,0	219,0	359,0	
	Delay alarm on [s]		0,30	0,30	0,30	0,30	
	Delay alarm off [s]		60	60	60	60	

Grey values can only be read (not changed) regardless of the code lock/sealing.

Main menu	Sub menu	Parameter menu	My Data	 Germany VDE-AR-N 4110:2018 + VDE-AR-N 4110:2023				
				3AC+N 57,7 V	3AC 100 V	3AC+N 230 V	3AC 400 V	
				Pr1.11 Ver. 02	Pr1.12 Ver. 02	Pr1.13 Ver. 02	Pr1.14 Ver. 02	
	U0 59v0	Alarm active		no	no	no	no	
		Alarm on [V]		46,0	80,0	46,0	80,0	
		Alarm off [V]		36,0	70,0	36,0	70,0	
		Delay alarm on [s]		1,50	1,50	1,50	1,50	
		Delay alarm off [s]		60	60	60	60	
		Display U0/UM> [s]		5,0	5,0	5,0	5,0	
Frequency	f >> 81.S2 81>S2	Alarm active		no	no	yes	yes	
		Alarm on [Hz]		51,50	51,50	52,50	52,50	
		Alarm off [Hz]		50,10	50,10	50,10	50,10	
		Delay alarm on [s]		0,10	0,10	0,10	0,10	
		Delay alarm off [s]		60	60	60	60	
	f > 81.S1 81>S1	Alarm active		no	no	yes	yes	
		Alarm on Hz		51,50	51,50	51,50	51,50	
		Alarm off Hz		50,10	50,10	50,10	50,10	
		Delay alarm on [s]		5,40	5,40	5,00	5,00	
		Delay alarm off [s]		60	60	60	60	
	f < 81.S1 81<S1	Alarm active		no	no	yes	yes	
		Alarm on [Hz]		47,50	47,50	47,50	47,50	
		Alarm off [Hz]		49,90	49,90	49,90	49,90	
		Delay alarm on [s]		0,40	0,40	0,10	0,10	
		Delay alarm off [s]		60	60	60	60	
	f << 81.S2 81<S2	Alarm active		no	no	no	no	
		Alarm on [Hz]		47,50	47,50	47,50	47,50	
		Alarm off [Hz]		49,90	49,90	49,90	49,90	
		Delay alarm on [s]		0,10	0,10	0,10	0,10	
		Delay alarm off [s]		60	60	60	60	
	f/U< protect	U< protect	Alarm active		no	no	no	no
			U< Limit [V]		20,0	20,0	46,0	46,0
		Frequency-range	Alarm active					
			Alarm U< on [V]					
Alarm U< off [V]								
Alarm 3U0 on [V]								
Alarm 3U0 off [V]								
Delay alarm on [s]								
Delay alarm off [s]								
Vector shift		Alarm active		no	no	no	no	
		VSR deg °		10,0	10,0	10,0	10,0	
		Delay alarm off [s]		3	3	3	3	
		suppression [s]		3	3	3	3	
ROCOF	Alarm active		no	no	no	no		
	df / dt		2,000	2,000	2,000	2,000		
	Periods		20	20	20	20		
	Delay alarm on [s]		0,10	0,10	0,10	0,10		
	Delay alarm off [s]		60	60	60	60		
Feed-back	Feedback at		off	off	off	off		
	Time for feedb. [s]		1,5	1,5	1,5	1,5		
	Reclosing attempts		2	2	2	2		
	Reclosing Time [s]		5	5	5	5		

Main menu	Sub menu	Parameter menu	My Data	 Germany VDE-AR-N 4110:2018 + VDE-AR-N 4110:2023			
				3AC+N 57,7 V Pr1.11 Ver. 02	3AC 100 V Pr1.12 Ver. 02	3AC+N 230 V Pr1.13 Ver. 02	3AC 400 V Pr1.14 Ver. 02
Relay K3		Relay function		life-contact	life-contact	life-contact	life-contact
		K3 pulse [s]		2,0	2,0	2,0	2,0
		K3 after K1+K2 [s]		0,1	0,1	0,1	0,1
Digital Inputs	E1-E2	Type		normally open	normally open	normally open	normally open
		Function		System off	System off	System off	System off
	In1	Type		normally open	normally open	normally open	normally open
		Function		Y1 inactive	Y1 inactive	Y1 inactive	Y1 inactive
		Sw.-on delay [s]					
	In2	Type		normally open	normally open	normally open	normally open
		Function		Y2 inactive	Y2 inactive	Y2 inactive	Y2 inactive
		Sw.-on delay [s]					
	In3	Type		normally open	normally open	normally open	normally open
		Function		Y1+Y2 inactive	Y1+Y2 inactive	Y1+Y2 inactive	Y1+Y2 inactive
		Sw.-on delay [s]					
	Network		Network		on	on	on
		DHCP					
		IP address					
		Subnet mask					
		Gateway					
		DNS server					
		MAC address					
Settings		Language					
		Date					
		Time					
		Display interval [s]		0,5	0,5	0,5	0,5
		Brightness [%]		50	50	50	50
		Dimming time [s]		300	300	300	300
		Factory setting		-	-	-	-
		Restart		-	-	-	-
		Code lock / Pin		off / 504	off / 504	off / 504	off / 504
Test/simulation		Relay					
		Simulation					
		Test K1/K2					
		switch back time [s]		60	60	60	60
Info		Firmware version					
		Serial number					
		Operating hours					
		Comment					

- Orange values -> only visible, if „function“ = „DI Release“ is set

Main menu	Sub menu	Parameter menu	My Data	 Germany VDE-AR-N 4110:2018 + VDE-AR-N 4110:2023			
				3AC+N 57,7 V Pr1.11 <i>Ver. 02</i>	3AC 100 V Pr1.12 <i>Ver. 02</i>	3AC+N 230 V Pr1.13 <i>Ver. 02</i>	3AC 400 V Pr1.14 <i>Ver. 02</i>
Counter	Alarm	Last reset					
		Number					
		List					
		Time sum					
		Reset					
	Standby	Last reset					
		Number					
		List					
		Time sum					
		Reset					
	Relay	Last reset					
		List					
		Reset					

15.4 VDE-AR-N 4120:2018-11

When changing the program, all parameters are reset.

				 Germany VDE-AR-N 4120:2018			
Main menu	Sub menu	Parameter menu	My Data	3AC+N 57,7 V	3AC 100 V	3AC+N 230 V	3AC 400 V
				Pr1.66 Ver. 00	Pr1.67 Ver. 00	Pr1.68 Ver. 00	Pr1.69 Ver. 00
Mains connection		Connection		3AC-N	3AC	3AC-N	3AC
		Nominal voltage [V]		57,7	100,0	230,0	400,0
		Coupling device		no	no	no	no
Switch on conditions	Voltage	Active		no	no	no	no
		U max. [V]		71,1	124,0	284,5	495,0
		U min. [V]		54,8	95,0	218,5	378,5
	Frequency	Active		no	no	no	no
		F max. [Hz]		50,10	50,10	50,10	50,10
		F min. [Hz]		49,90	49,90	49,90	49,90
	Switch on delay	Time [s]		0	0	0	0
	After alarms	Switch back		all F+U<+U<<	all F+U<+U<<	all F+U<+U<<	all F+U<+U<<
Short alarm	Active						
Voltage	U >> 59.S2 59>S2	Alarm active		yes	yes	yes	yes
		Alarm on [V]		72,1	125,0	287,5	498,0
		Alarm off [V]		71,1	124,0	284,5	495,0
		Delay alarm on [s]		0,10	0,10	0,10	0,10
		Delay alarm off [s]		0	0	0	0
	U > 59.S1 59>S1	Alarm active		no	no	no	no
		Alarm on [V]		63,5	110,0	253,0	438,2
		Alarm off [V]		62,5	109,0	250,0	435,2
		Delay alarm on [s]		60,00	60,00	60,00	60,00
		Delay alarm off [s]		0	0	0	0
	UM> 59-Av	Alarm active		no	no	no	no
		Alarm on [V]		63,5	110,0	253,0	438,2
		Alarm off [V]		62,5	109,0	250,0	435,2
		Delay alarm on [s]		60,00	60,00	60,00	60,00
		Delay alarm off [s]		0	0	0	0
	U < 27.S1 27<S1	Alarm active		yes	yes	yes	yes
		Alarm on [V]		46,2	80,0	184,0	318,7
		Alarm off [V]		54,8	95,0	218,5	378,5
		Delay alarm on [s]		3,00	3,00	3,00	3,00
		Delay alarm off [s]		0	0	0	0
U << 27.S2 27<S2	Alarm active		yes	yes	yes	yes	
	Alarm on [V]		17,3	30,0	69,0	119,5	
	Alarm off [V]		54,8	95,0	218,5	378,5	
	Delay alarm on [s]		1,50	1,50	1,50	1,50	
	Delay alarm off [s]		0	0	0	0	

Grey values can only be read (not changed) regardless of the code lock/sealing.

				 Germany VDE-AR-N 4120:2018				
Main menu	Sub menu	Parameter menu	My Data	3AC+N 230 V	3AC 400 V	3AC+N 230 V	3AC 400 V	
				Pr1.66 Ver. 00	Pr1.67 Ver. 00	Pr1.68 Ver. 00	Pr1.69 Ver. 00	
	U0 59v0	Alarm active		no	no	no	no	
		Alarm on [V]		46,0	46,0	46,0	46,0	
		Alarm off [V]		36,0	36,0	36,0	36,0	
		Delay alarm on [s]		1,50	1,50	1,50	1,50	
		Delay alarm off [s]		0	0	0	0	
		Display U0/UM> [s]		5,0	5,0	5,0	5,0	
Frequency	f >> 81.S2 81>S2	Alarm active		yes	yes	yes	yes	
		Alarm on [Hz]		52,50	52,50	52,50	52,50	
		Alarm off [Hz]		50,10	50,10	50,10	50,10	
		Delay alarm on [s]		0,09	0,09	0,09	0,09	
		Delay alarm off [s]		0	0	0	0	
	f > 81.S1 81>S1	Alarm active		no	no	no	no	
		Alarm on Hz		51,50	51,50	51,50	51,50	
		Alarm off Hz		50,10	50,10	50,10	50,10	
		Delay alarm on [s]		5,00	5,00	5,00	5,00	
	f < 81.S1 81<S1	Alarm active		yes	yes	yes	yes	
		Alarm on [Hz]		47,50	47,50	47,50	47,50	
		Alarm off [Hz]		49,90	49,90	49,90	49,90	
		Delay alarm on [s]		0,09	0,09	0,09	0,09	
	f << 81.S2 81<S2	Alarm active		no	no	no	no	
		Alarm on [Hz]		47,50	47,50	47,50	47,50	
		Alarm off [Hz]		49,90	49,90	49,90	49,90	
		Delay alarm on [s]		0,09	0,09	0,09	0,09	
	f/U< protect Frequency-range	f/U< protect	Alarm active		no	no	no	no
			U< Limit [V]		20,0	20,0	20,0	20,0
		Frequency-range	Alarm active					
Alarm U< on [V]								
Alarm U< off [V]								
Alarm 3U0 on [V]								
Alarm 3U0 off [V]								
Delay alarm on [s]								
Vector shift			Alarm active		no	no	no	no
			VSR deg °		10,0	10,0	10,0	10,0
			Delay alarm off [s]		3	3	3	3
			suppression [s]		3	3	3	3
			ROCOP		Alarm active		no	no
df / dt		2,000	2,000		2,000	2,000		
Periods		20	20		20	20		
Delay alarm on [s]		0,10	0,10		0,10	0,10		
Delay alarm off [s]		0	0		0	0		
Feed-back		Feedback at		off	off	off	off	
		Time for feedb. [s]		1,5	1,5	1,5	1,5	
		Reclosing attempts		2	2	2	2	
		Reclosing Time [s]		5	5	5	5	

				 Germany VDE-AR-N 4120:2018			
Main menu	Sub menu	Parameter menu	My Data	3AC+N 230 V	3AC 400 V	3AC+N 230 V	3AC 400 V
				Pr1.66 Ver. 00	Pr1.67 Ver. 00	Pr1.68 Ver. 00	Pr1.69 Ver. 00
Relay K3		Relay function		life-contact	life-contact	life-contact	life-contact
		K3 pulse [s]		2,0	2,0	2,0	2,0
		K3 after K1+K2 [s]		0,1	0,1	0,1	0,1
Digital Inputs	E1-E2	Type		normally open	normally open	normally open	normally open
		Function		System off	System off	System off	System off
	In1	Type		normally open	normally open	normally open	normally open
		Function		DI Release	DI Release	DI Release	DI Release
		Sw.-on delay [s]					
	In2	Type		normally open	normally open	normally open	normally open
		Function		Y1 inactive	Y1 inactive	Y1 inactive	Y1 inactive
		Sw.-on delay [s]					
	In3	Type		normally open	normally open	normally open	normally open
		Function		Y2 inactive	Y2 inactive	Y2 inactive	Y2 inactive
		Sw.-on delay [s]		600	600	600	600
	Network		Network		on	on	on
		DHCP					
		IP address					
		Subnet mask					
		Gateway					
		DNS server					
		MAC address					
Settings		Language					
		Date					
		Time					
		Display interval [s]		0,5	0,5	0,5	0,5
		Brightness [%]		50	50	50	50
		Dimming time [s]		300	300	300	300
		Factory setting		-	-	-	-
		Restart		-	-	-	-
		Code lock / Pin		off / 504	off / 504	off / 504	off / 504
Test/ simulation		Relay					
		Simulation					
		Test K1/K2					
		switch back time		0	0	0	0
Info		Firmware version					
		Serial number					
		Operating hours					
		Comment					

- Orange values -> only visible, if „function“ = „DI Release“ is set

Main menu	Sub menu	Parameter menu	My Data	 Germany VDE-AR-N 4120:2018			
				3AC+N 230 V Pr1.66 <i>Ver. 00</i>	3AC 400 V Pr1.67 <i>Ver. 00</i>	3AC+N 230 V Pr1.68 <i>Ver. 00</i>	3AC 400 V Pr1.69 <i>Ver. 00</i>
Counter	Alarm	Last reset					
		Number					
		List					
		Time sum					
		Reset					
	Standby	Last reset					
		Number					
		List					
		Time sum					
		Reset					
	Relay	Last reset					
		List					
		Reset					

15.5 VDE-AR-N 4130:2018-11

When changing the program, all parameters are reset.

				 Germany VDE-AR-N 4130:2018			
Main menu	Sub menu	Parameter menu	My Data	3AC+N 57,7 V	3AC 100 V	3AC+N 230 V	3AC 400 V
				Pr1.60 Ver. 00	Pr1.61 Ver. 00	Pr1.62 Ver. 00	Pr1.63 Ver. 00
Mains connection		Connection		3AC-N	3AC	3AC-N	3AC
		Nominal voltage [V]		57,7	100,0	230,0	400,0
		Coupling device		no	no	no	no
Switch on conditions	Voltage	Active		no	no	no	no
		U max. [V]		71,1	124,0	284,5	495,0
		U min. [V]		54,8	95,0	218,5	378,5
	Frequency	Active		no	no	no	no
		F max. [Hz]		50,10	50,10	50,10	50,10
		F min. [Hz]		49,90	49,90	49,90	49,90
	Switch on delay	Time [s]		0	0	0	0
	After alarms	Switch back		all F+U<+U<<	all F+U<+U<<	all F+U<+U<<	all F+U<+U<<
Short alarm	Active						
Voltage	U >> 59.S2 59>S2	Alarm active		yes	yes	yes	yes
		Alarm on [V]		72,1	125,0	287,5	498,0
		Alarm off [V]		71,1	124,0	284,5	495,0
		Delay alarm on [s]		0,10	0,10	0,10	0,10
		Delay alarm off [s]		0	0	0	0
	U > 59.S1 59>S1	Alarm active		no	no	no	no
		Alarm on [V]		63,5	110,0	253,0	438,2
		Alarm off [V]		62,5	109,0	250,0	435,2
		Delay alarm on [s]		60,00	60,00	60,00	60,00
		Delay alarm off [s]		0	0	0	0
	UM> 59-Av	Alarm active		no	no	no	no
		Alarm on [V]		63,5	110,0	253,0	438,2
		Alarm off [V]		62,5	109,0	250,0	435,2
		Delay alarm on [s]		60,00	60,00	60,00	60,00
		Delay alarm off [s]		0	0	0	0
	U < 27.S1 27<S1	Alarm active		yes	yes	yes	yes
		Alarm on [V]		46,2	80,0	184,0	318,7
		Alarm off [V]		54,8	95,0	218,5	378,5
		Delay alarm on [s]		3,00	3,00	3,00	3,00
		Delay alarm off [s]		0	0	0	0
U << 27.S2 27<S2	Alarm active		yes	yes	yes	yes	
	Alarm on [V]		17,3	30,0	69,0	119,5	
	Alarm off [V]		54,8	95,0	218,5	378,5	
	Delay alarm on [s]		1,50	1,50	1,50	1,50	
	Delay alarm off [s]		0	0	0	0	

Grey values can only be read (not changed) regardless of the code lock/sealing.

				 Germany VDE-AR-N 4130:2018				
Main menu	Sub menu	Parameter menu	My Data	3AC+N 230 V	3AC 400 V	3AC+N 230 V	3AC 400 V	
				Pr1.60 Ver. 00	Pr1.61 Ver. 00	Pr1.62 Ver. 00	Pr1.63 Ver. 00	
	U0 59v0	Alarm active		no	no	no	no	
		Alarm on [V]		46,0	46,0	46,0	46,0	
		Alarm off [V]		36,0	36,0	36,0	36,0	
		Delay alarm on [s]		1,50	1,50	1,50	1,50	
		Delay alarm off [s]		0	0	0	0	
		Display U0/UM> [s]		5,0	5,0	5,0	5,0	
Frequency	f >> 81.S2 81>S2	Alarm active		yes	yes	yes	yes	
		Alarm on [Hz]		52,50	52,50	52,50	52,50	
		Alarm off [Hz]		50,10	50,10	50,10	50,10	
		Delay alarm on [s]		0,09	0,09	0,09	0,09	
		Delay alarm off [s]		0	0	0	0	
	f > 81.S1 81>S1	Alarm active		no	no	no	no	
		Alarm on Hz		51,50	51,50	51,50	51,50	
		Alarm off Hz		50,10	50,10	50,10	50,10	
		Delay alarm on [s]		5,00	5,00	5,00	5,00	
	f < 81.S1 81<S1	Alarm active		yes	yes	yes	yes	
		Alarm on [Hz]		47,50	47,50	47,50	47,50	
		Alarm off [Hz]		49,90	49,90	49,90	49,90	
		Delay alarm on [s]		0,09	0,09	0,09	0,09	
	f << 81.S2 81<S2	Alarm active		no	no	no	no	
		Alarm on [Hz]		47,50	47,50	47,50	47,50	
		Alarm off [Hz]		49,90	49,90	49,90	49,90	
		Delay alarm on [s]		0,09	0,09	0,09	0,09	
	f/U< protect Frequency-range	f/U< protect	Alarm active		no	no	no	no
			U< Limit [V]		20,0	20,0	20,0	20,0
		Frequency-range	Alarm active					
Alarm U< on [V]								
Alarm U< off [V]								
Alarm 3U0 on [V]								
Alarm 3U0 off [V]								
Delay alarm on [s]								
Vector shift			Alarm active		no	no	no	no
			VSR deg °		10,0	10,0	10,0	10,0
			Delay alarm off [s]		3	3	3	3
			suppression [s]		3	3	3	3
ROCOF			Alarm active		no	no	no	no
	df / dt			2,000	2,000	2,000	2,000	
	Periods			20	20	20	20	
	Delay alarm on [s]			0,10	0,10	0,10	0,10	
	Delay alarm off [s]			0	0	0	0	
Feed-back		Feedback at		off	off	off	off	
		Time for feedb. [s]		1,5	1,5	1,5	1,5	
		Reclosing attempts		2	2	2	2	
		Reclosing Time [s]		5	5	5	5	





Main menu	Sub menu	Parameter menu	My Data	 Germany VDE-AR-N 4130:2018			
				3AC+N 230 V	3AC 400 V	3AC+N 230 V	3AC 400 V
				Pr1.60 <i>Ver. 00</i>	Pr1.61 <i>Ver. 00</i>	Pr1.62 <i>Ver. 00</i>	Pr1.63 <i>Ver. 00</i>
Relay K3		Relay function		life-contact	life-contact	life-contact	life-contact
		K3 pulse [s]		2,0	2,0	2,0	2,0
		K3 after K1+K2 [s]		0,1	0,1	0,1	0,1
Digital Inputs	E1-E2	Type		normally open	normally open	normally open	normally open
		Function		System off	System off	System off	System off
	In1	Type		normally open	normally open	normally open	normally open
		Function		DI Release	DI Release	DI Release	DI Release
		Sw.-on delay [s]					
	In2	Type		normally open	normally open	normally open	normally open
		Function		Y1 inactive	Y1 inactive	Y1 inactive	Y1 inactive
		Sw.-on delay [s]					
	In3	Type		normally open	normally open	normally open	normally open
		Function		Y2 inactive	Y2 inactive	Y2 inactive	Y2 inactive
		Sw.-on delay [s]		600	600	600	600
	Network		Network		on	on	on
		DHCP					
		IP address					
		Subnet mask					
		Gateway					
		DNS server					
		MAC address					
Settings		Language					
		Date					
		Time					
		Display interval [s]		0,5	0,5	0,5	0,5
		Brightness [%]		50	50	50	50
		Dimming time [s]		300	300	300	300
		Factory setting		-	-	-	-
		Restart		-	-	-	-
		Code lock / Pin		off / 504	off / 504	off / 504	off / 504
Test/simulation		Relay					
		Simulation					
		Test K1/K2					
		switch back time		0	0	0	0
Info		Firmware version					
		Serial number					
		Operating hours					
		Comment					

- Orange values -> only visible, if „function“ = „DI Release“ is set





Main menu	Sub menu	Parameter menu	My Data	 Germany VDE-AR-N 4120:2018			
				3AC+N 230 V Pr1.66 <i>Ver. 00</i>	3AC 400 V Pr1.67 <i>Ver. 00</i>	3AC+N 230 V Pr1.68 <i>Ver. 00</i>	3AC 400 V Pr1.69 <i>Ver. 00</i>
Counter	Alarm	Last reset					
		Number					
		List					
		Time sum					
		Reset					
	Standby	Last reset					
		Number					
		List					
		Time sum					
		Reset					
	Relay	Last reset					
		List					
		Reset					





15.6 TOR Erzeuger Typ A,B,C,D + NA/EEA-NE7 CH 2020 + C10/C11 + G98(G83/2)+G99(G59/3)

When changing the program, all parameters are reset.





Main menu	Sub menu	Parameter menu	My Data							
				Offtria TOR Erzeuger Typ A-D 3AC+N 230 V Pr1.10 Ver. 00	Switzerland NE/EEA NE7 CH2020 3AC + 3AC+N 230 V Pr1.15 Ver. 00	Belgium C10/11 3AC+N 230 V Pr1.16 Ver. 00	United Kingdom G98 (G83/2) + G99 (G59/3) 3AC+N 230 V 3AC 400 V 3AC+N 63,5 V 3AC 110 V Pr1.20 Ver. 01 Pr1.21 Ver. 01 Pr1.22 Ver. 01 Pr1.23 Ver. 01			
Mains connection		Connection		3AC-N	3AC-N / 3AC	3AC-N	3AC-N	3AC	3AC-N	3AC
		Nominal voltage [V]		230,0	230,0	230,0	230,0	400,0	63,5	110,0
		Coupling device		no	no	no	no	no	no	no
Switch on conditions	Voltage	Active		no	no	no	no	no	no	no
		U max. [V]		250,7	253,0	248,0	257,0	451,0	68,8	120,0
		U min. [V]		195,5	196,0	166,0	189,0	325,0	51,8	89,0
	Frequency	Active		no	no	no	no	no	no	no
		F max. [Hz]		50,10	50,10	50,10	50,05	50,05	50,05	50,05
		F min. [Hz]		47,60	47,60	49,90	48,50	48,50	48,50	48,50
	Switch on delay	Time [s]		60	60	1	20	20	20	20
After alarms	Switch back		all F+U<+U< <	triggered	triggered	triggered	triggered	triggered	triggered	
Short alarm	Active									
Voltage	U >> 59.S2 59>S2	Alarm active		yes	yes	yes	yes	yes	yes	yes
		Alarm on [V]		264,0	276,0	264,0	273,0	476,0	71,7	124,0
		Alarm off [V]		250,7	253,0	259,0	268,0	471,0	70,7	123,0
		Delay alarm on [s]		0,10	0,10	0,05	0,50	0,50	0,50	0,50
		Delay alarm off [s]		60	60	1	20	20	20	20
	U > 59.S1 59>S1	Alarm active		no	no	yes	yes	yes	yes	yes
		Alarm on [V]		255,0	253,0	253,0	262,0	456,0	69,8	121,0
		Alarm off [V]		250,7	250,0	248,0	257,0	451,0	68,8	120,0
		Delay alarm on [s]		60,00	60,00	1,00	1,00	1,00	1,00	1,00
		Delay alarm off [s]		60	60	1	20	20	20	20
	UM> 59-Av	Alarm active		yes	yes	no	no	no	no	no
		Alarm on [V]		255,0	253,0	253,0	262,0	456,0	65,8	121,0
		Alarm off [V]		250,7	250,0	248,0	257,0	451,0	64,8	120,0
		Delay alarm on [s]		0,10	0,10	1,00	1,00	1,00	1,00	1,00
		Delay alarm off [s]		60	60	1	20	20	20	20
	U < 27.S1 27<S1	Alarm active		yes	yes	yes	no	no	no	no
		Alarm on [V]		184,0	184,0	161,0	200,0	348,0	50,2	95,7
		Alarm off [V]		195,5	196,0	166,0	205,0	353,0	51,2	96,7
		Delay alarm on [s]		1,00	1,50	1,50	2,50	2,50	2,50	2,50
		Delay alarm off [s]		60	60	1	20	20	20	20
U << 27.S2 27<S2	Alarm active		yes	yes	yes	yes	yes	yes	yes	
	Alarm on [V]		69,0	104,0	57,0	184,0	320,0	50,8	88,0	
	Alarm off [V]		195,5	196,0	62,0	189,0	325,0	51,8	89,0	
	Delay alarm on [s]		0,20	0,30	0,05	2,50	2,50	2,50	2,50	
	Delay alarm off [s]		60	60	1	20	20	20	20	

Grey values can only be read (not changed) regardless of the code lock/sealing.

Main menu	Sub menu	Parameter menu	My Data								
				Offtria TOR Erzeuger Typ A-D	Switzerland NE/EEA NE7 CH2020 3AC + 3AC+N 230 V	Belgium C10/11 3AC+N 230 V	United Kingdom G98 (G83/2) + G99 (G59/3)				
				Pr1.10 Ver. 00	Pr1.15 Ver. 00	Pr1.16 Ver. 00	Pr1.20 Ver. 01	Pr1.21 Ver. 01	Pr1.22 Ver. 01	Pr1.23 Ver. 01	
	U0 59v0	Alarm active		no	no	no	no	no	no	no	
		Alarm on [V]		46,0	46,0	46,0	46,0	80,0	46,0	80,0	
		Alarm off [V]		36,0	36,0	36,0	36,0	70,0	36,0	70,0	
		Delay alarm on [s]		1,50	1,50	1,50	1,50	1,50	1,50	1,50	
		Delay alarm off [s]		60	60	1	60	60	60	60	
		Display U0/UM> [s]		5,0	5,0	5,0	5,0	5,0	5,0	5,0	
Frequency	f >> 81.S2 81>S2	Alarm active		no	no	no	yes	yes	yes	yes	
		Alarm on [Hz]		51,50	51,50	50,30	52,00	52,00	52,00	52,00	
		Alarm off [Hz]		50,10	50,10	50,10	50,05	50,05	50,05	50,05	
		Delay alarm on [s]		0,10	0,10	0,05	0,50	0,50	0,50	0,50	
		Delay alarm off [s]		60	60	1	20	20	20	20	
	f > 81.S1 81>S1	Alarm active		yes	yes	yes	no	no	no	no	
		Alarm on Hz		51,50	51,50	51,50	51,50	51,50	51,50	51,50	
		Alarm off Hz		50,10	50,10	50,10	50,05	50,05	50,05	50,05	
		Delay alarm on [s]		0,10	0,10	0,05	90,00	90,00	90,00	90,00	
		Delay alarm off [s]		60	60	1	20	20	20	20	
	f < 81.S1 81<S1	Alarm active		yes	yes	yes	yes	yes	yes	yes	
		Alarm on [Hz]		47,50	47,50	47,50	47,50	47,50	47,50	47,50	
		Alarm off [Hz]		47,60	47,60	49,90	48,50	48,50	48,50	48,50	
		Delay alarm on [s]		0,10	0,10	0,05	20,00	20,00	20,00	20,00	
		Delay alarm off [s]		60	60	1	20	20	20	20	
	f << 81.S2 81<S2	Alarm active		no	no	no	yes	yes	yes	yes	
		Alarm on [Hz]		47,50	47,50	49,70	47,00	47,00	47,00	47,00	
		Alarm off [Hz]		47,60	47,60	49,90	48,00	48,00	48,00	48,00	
		Delay alarm on [s]		0,10	0,10	0,05	0,50	0,50	0,50	0,50	
		Delay alarm off [s]		60	60	1	20	20	20	20	
	Vector shift	f/U< protect	Alarm active		no	no	no	no	no	no	no
			U< Limit [V]		46,0	161,0	20,0	46,0	46,0	20,0	20,0
		Frequency-range	Alarm active				no				
			Alarm U< on [V]				196,0				
Alarm U< off [V]						199,0					
Alarm 3U0 on [V]						11,5					
Alarm 3U0 off [V]						10,5					
Delay alarm on [s]						0,05					
Delay alarm off [s]						1					
Vector shift		Alarm active		no	no	no	no	no	no	no	
		VSR deg °		10,0	10,0	7,0	50,0	50,0	50,0	50,0	
		Delay alarm off [s]		60	3	20	20	20	20	20	
		suppression [s]		2	2	2	2	2	2	2	
ROCOF	Alarm active		no	no	yes	yes	yes	yes	yes		
	df / dt		0,800	2,000	1,000	1,000	1,000	1,000	1,000		
	Periods		20	20	8	20	20	20	20		
	Delay alarm on [s]		0,10	0,10	0,20	0,50	0,50	0,50	0,50		
	Delay alarm off [s]		60	60	1	20	20	20	20		
Feed-back	Feedback at		off	Y1	off	off	off	off	off		
	Time for feedb. [s]		1,5	5,0	1,5	1,5	1,5	1,5	1,5		
	Reclosing attempts		2	2	2	2	2	2	2		
	Reclosing Time [s]		5	5	5	5	5	5	5		

Main menu	Sub menu	Parameter menu	My Data							
				Offtria TOR Erzeuger Typ A-D 3AC+N 230 V Pr1.10 Ver. 00	Switzerland NE/EEA NE7 CH2020 3AC + 3AC+N 230 V Pr1.15 Ver. 00	Belgium C10/11 3AC+N 230 V Pr1.16 Ver. 00	United Kingdom G98 (G83/2) + G99 (G59/3) 3AC+N 230 V 3AC 400 V 3AC+N 63,5 V 3AC 110 V Pr1.20 Ver. 01 Pr1.21 Ver. 01 Pr1.22 Ver. 01 Pr1.23 Ver. 01			
Relay K3		Relay function		life-contact	life-contact	life-contact	life-contact	life-contact	life-contact	life-contact
		K3 pulse [s]		2,0	2,0	2,0	2,0	2,0	2,0	2,0
		K3 after K1+K2 [s]		0,1	0,1	0,1	0,1	0,1	0,1	0,1
Digital Inputs	E1-E2	Type		normally open	normally open	normally open	normally open	normally open	normally open	normally open
		Function		System off	System off	System off	System off	System off	System off	System off
	In1	Type		normally open	normally open	normally open	normally open	normally open	normally open	normally open
		Function		Y1 inactive	Y1 inactive	Y1 inactive	Y1 inactive	Y1 inactive	Y1 inactive	Y1 inactive
		Sw.-on delay [s]								
	In2	Type		normally open	normally open	normally open	normally open	normally open	normally open	normally open
		Function		Y2 inactive	Y2 inactive	Y2 inactive	Y2 inactive	Y2 inactive	Y2 inactive	Y2 inactive
		Sw.-on delay [s]								
	In3	Type		normally open	normally open	normally open	normally open	normally open	normally open	normally open
		Function		Y1+Y2 inactive	Y1+Y2 inactive	Y1+Y2 inactive	Y1+Y2 inactive	Y1+Y2 inactive	Y1+Y2 inactive	Y1+Y2 inactive
		Sw.-on delay [s]								
	Network		Network					off	off	off
		DHCP								
		IP address								
		Subnet mask								
		Gateway								
		DNS server								
		MAC address								
Settings		Language								
		Date								
		Time								
		Display interval [s]		0,5	0,5	0,5	0,5	0,5	0,5	0,5
		Brightness [%]		50	50	50	50	50	50	50
		Dimming time [s]		300	300	300	300	300	300	300
		Factory setting		-	-	-	-	-	-	-
		Restart		-	-	-	-	-	-	-
		Code lock / Pin		off / 504	off / 504	off / 504	off / 504	off / 504	off / 504	off / 504
Test/ simulation		Relay								
		Simulation								
		Test K1/K2								
		switch back time [s]		60	60	1	unequal	unequal	unequal	unequal
Info		Firmware version								
		Serial number								
		Operating hours								
		Comment								

- Orange values -> only visible, if „function“ = „DI Release“ is set





Main menu	Sub menu	Parameter menu	My Data							
				Offtria TOR Erzeuger Typ A-D 3AC+N 230 V Pr1.10 <i>Ver. 00</i>	Switzerland NE/EEA NE7 CH2020 3AC + 3AC+N 230 V Pr1.15 <i>Ver. 00</i>	Belgium C10/11 3AC+N 230 V Pr1.16 <i>Ver. 00</i>	United Kingdom G98 (G83/2) + G99 (G59/3) 3AC+N 230 V Pr1.20 <i>Ver. 01</i> 3AC 400 V Pr1.21 <i>Ver. 01</i> 3AC+N 63,5 V Pr1.22 <i>Ver. 01</i> 3AC 110 V Pr1.23 <i>Ver. 01</i>			
Counter	Alarm	Last reset								
		Number								
		List								
		Time sum								
		Reset								
	Standby	Last reset								
		Number								
		List								
		Time sum								
	Relay	Reset								
		Last reset								
		List								
		Reset								

15.7 SFS-EN50549-1+2:2019 + EN50549-1 2-stage + NEN-EN50549-1:2019 + VDE 0126 VFR2019

When changing the program, all parameters are reset.





Main menu	Sub menu	Parameter menu	My Data	Finland SFS-EN50549-1+2:2019		Ireland EN50549-1 2-stage		Netherlands NEN-EN50549-1:2019	France VDE 0126 VFR2019
				3AC+N 230 V Pr1.30 Ver. 00	3AC 400 V Pr1.31 Ver. 00	3AC+N 230 V Pr1.32 Ver. 00	3AC 400 V Pr1.33 Ver. 00	3AC+N 230 V Pr1.34 Ver. 00	3AC+N 230 V Pr1.36 Ver. 00
Mains connection		Connection		3AC-N	3AC	3AC-N	3AC	3AC-N	3AC-N
		Nominal voltage [V]		230,0	400,0	230,0	400,0	230,0	230,0
		Coupling device		no	no	no	no	no	no
Switch on conditions	Voltage	Active		no	no	no	no	no	no
		U max. [V]		253,0	438,0	264,0	463,0	253,0	261,0
		U min. [V]		195,5	337,9	196,0	337,0	195,5	187,0
	Frequency	Active		no	no	no	no	no	no
		F max. [Hz]		51,00	51,00	50,15	50,15	50,10	50,05
		F min. [Hz]		49,00	49,00	47,90	47,90	48,50	48,50
	Switch on delay	Time [s]		60	60	20	20	60	60
	After alarms	Switch back		triggered	triggered	triggered	triggered	triggered	triggered
Short alarm	Active								
Voltage	U >> 59.S2 59>S2	Alarm active		no	no	yes	yes	yes	yes
		Alarm on [V]		276,0	478,0	281,0	488,0	276,0	264,0
		Alarm off [V]		253,0	438,0	276,0	483,0	253,0	261,0
		Delay alarm on [s]		1,00	1,00	0,70	0,70	0,10	0,10
		Delay alarm off [s]		60	60	20	20	60	60
	U > 59.S1 59>S1	Alarm active		yes	yes	yes	yes	no	no
		Alarm on [V]		276,0	478,0	269,0	468,0	253,0	249,0
		Alarm off [V]		253,0	438,0	264,0	463,0	250,0	246,0
		Delay alarm on [s]		1,00	1,00	70,00	70,00	0,20	60,00
		Delay alarm off [s]		60	60	20	20	60	60
	UM> 59-Av	Alarm active		yes	yes	no	no	yes	no
		Alarm on [V]		253,0	438,0	262,0	456,0	253,0	253,0
		Alarm off [V]		250,0	433,0	257,0	451,0	250,0	250,0
		Delay alarm on [s]		0,10	0,10	1,00	70,00	0,20	0,10
		Delay alarm off [s]		60	60	20	20	60	60
	U < 27.S1 27<S1	Alarm active		yes	yes	yes	yes	yes	yes
		Alarm on [V]		184,0	318,0	191,0	332,0	184,0	184,0
		Alarm off [V]		195,5	337,9	196,0	337,0	195,5	187,0
		Delay alarm on [s]		1,50	1,50	0,70	0,70	3,00	2,70
		Delay alarm off [s]		60	60	20	20	60	60
U << 27.S2 27<S2	Alarm active		yes	yes	no	no	yes	no	
	Alarm on [V]		46,0	79,7	184,0	320,0	69,0	104,0	
	Alarm off [V]		195,5	259,7	189,0	325,0	195,5	106,0	
	Delay alarm on [s]		0,25	0,25	2,50	2,50	0,10	0,30	
	Delay alarm off [s]		60	60	20	20	60	60	

Grey values can only be read (not changed) regardless of the code lock/sealing.

Main menu	Sub menu	Parameter menu	My Data	 Finland SFS-EN50549-1+2:2019		 Ireland EN50549-1 2-stage		 Netherlands NEN-EN50549-1:2019	 France VDE 0126 VFR2019
				3AC+N 230 V	3AC 400 V	3AC+N 230 V	3AC 400 V	3AC+N 230 V	3AC+N 230 V
				Pr1.30 Ver. 00	Pr1.31 Ver. 00	Pr1.32 Ver. 00	Pr1.33 Ver. 00	Pr1.34 Ver. 00	Pr1.36 Ver. 00
U0	59v0	Alarm active	no	no	no	no	no	no	no
		Alarm on [V]	46,0	80,0	46,0	80,0	46,0	46,0	46,0
		Alarm off [V]	36,0	70,0	36,0	70,0	36,0	36,0	36,0
		Delay alarm on [s]	1,50	1,50	1,50	1,50	1,50	1,50	1,50
		Delay alarm off [s]	60	60	60	60	60	60	60
		Display U0/UM> [s]	5,0	5,0	5,0	5,0	5,0	5,0	5,0
Frequency	f >> 81.S2 81>S2	Alarm active	no	no	yes	yes	no	no	
		Alarm on [Hz]	51,50	51,50	52,10	52,10	51,50	51,50	
		Alarm off [Hz]	51,00	51,00	50,15	50,15	50,10	50,05	
		Delay alarm on [s]	0,20	0,20	0,50	0,50	0,10	0,10	
	f > 81.S1 81>S1	Alarm active	yes	yes	no	no	yes	yes	
		Alarm on Hz	51,50	51,50	51,50	51,50	51,50	51,50	
		Alarm off Hz	51,00	51,00	50,05	50,05	50,10	50,05	
		Delay alarm on [s]	0,20	0,20	90,00	90,00	0,10	0,10	
	f < 81.S1 81<S1	Alarm active	yes	yes	no	no	yes	yes	
		Alarm on [Hz]	47,50	47,50	47,50	47,50	47,50	47,50	
		Alarm off [Hz]	49,00	49,00	48,50	48,50	48,50	48,50	
		Delay alarm on [s]	0,20	0,20	20,00	20,00	0,10	0,10	
	f << 81.S2 81<S2	Alarm active	no	no	yes	yes	no	no	
		Alarm on [Hz]	47,50	47,50	46,90	46,90	47,50	47,50	
		Alarm off [Hz]	49,00	49,00	47,90	47,90	48,50	48,50	
		Delay alarm on [s]	0,20	0,20	0,50	0,50	0,10	0,10	
	f/U< protect	Alarm active	U< Limit [V]	46,0	46,0	46,0	46,0	46,0	46,0
			Frequency-range	Alarm active					
f/U< protect		Frequency-range	Alarm U< on [V]						
			Alarm U< off [V]						
			Alarm 3U0 on [V]						
			Alarm 3U0 off [V]						
			Delay alarm on [s]						
			Delay alarm off [s]						
Vector shift			Alarm active	no	no	no	no	no	no
			VSR deg °	10,0	10,0	50,0	50,0	10,0	10,0
			Delay alarm off [s]	3	3	20	20	60	3
			suppression [s]	2	2	2	2	2	3
ROCOF		Alarm active	no	no	yes	yes	no	no	
		df / dt	2,000	2,000	1,000	1,000	0,800	0,800	
		Periods	20	20	20	20	20	20	
		Delay alarm on [s]	0,50	0,50	0,60	0,60	0,10	0,10	
		Delay alarm off [s]	60	60	20	20	60	60	
Feed-back		Feedback at	off	off	off	off	off	off	
		Time for feedb. [s]	1,5	1,5	1,5	1,5	1,5	1,5	
		Reclosing attempts	2	2	2	2	2	2	
		Reclosing Time [s]	5	5	5	5	5	5	



Main menu	Sub menu	Parameter menu	My Data	Finland SFS-EN50549-1+2:2019		Ireland EN50549-1 2-stage		Netherlands NEN-EN50549-1:2019	France VDE 0126 VFR2019
				3AC+N 230 V Pr1.30 Ver. 00	3AC 400 V Pr1.31 Ver. 00	3AC+N 230 V Pr1.32 Ver. 00	3AC 400 V Pr1.33 Ver. 00	3AC+N 230 V Pr1.34 Ver. 00	3AC+N 230 V Pr1.36 Ver. 00
Relay K3		Relay function		life-contact	life-contact	life-contact	life-contact	life-contact	life-contact
		K3 pulse [s]		2,0	2,0	2,0	2,0	2,0	2,0
		K3 after K1+K2 [s]		0,1	0,1	0,1	0,1	0,1	0,1
Digital Inputs	E1-E2	Type		normally open	normally open	normally open	normally open	normally open	normally open
		Function		System off	System off	System off	System off	System off	System off
	In1	Type		normally open	normally open	normally open	normally open	normally open	normally open
		Function		Y1 inactive	Y1 inactive	Y1 inactive	Y1 inactive	Y1 inactive	Y1 inactive
		Sw.-on delay [s]							
	In2	Type		normally open	normally open	normally open	normally open	normally open	normally open
		Function		Y2 inactive	Y2 inactive	Y2 inactive	Y2 inactive	Y2 inactive	Y2 inactive
		Sw.-on delay [s]							
	In3	Type		normally open	normally open	normally open	normally open	normally open	normally open
		Function		Y1+Y2 inactive	Y1+Y2 inactive	Y1+Y2 inactive	Y1+Y2 inactive	Y1+Y2 inactive	Y1+Y2 inactive
		Sw.-on delay [s]							
	Network		Network						
		DHCP							
		IP address							
		Subnet mask							
		Gateway							
		DNS server							
		MAC address							
Settings		Language							
		Date							
		Time							
		Display interval [s]		0,5	0,5	0,5	0,5	0,5	0,5
		Brightness [%]		50	50	50	50	50	50
		Dimming time [s]		300	300	300	300	300	300
		Factory setting		-	-	-	-	-	-
		Restart		-	-	-	-	-	-
		Code lock / Pin		off / 504	off / 504	off / 504	off / 504	off / 504	off / 504
Test/ simulation		Relay							
		Simulation							
		Test K1/K2							
		switch back time [s]		60	60	unequal	unequal	60	60
Info		Firmware version							
		Serial number							
		Operating hours							
		Comment							

- Orange values -> only visible, if „function“ = „DI Release“ is set

Main menu	Sub menu	Parameter menu	My Data	 Finland SFS-EN50549-1+2:2019		 Ireland EN50549-1 2-stage		 Netherlands NEN-EN50549-1:2019	 France VDE 0126 VFR2019
				3AC+N 230 V Pr1.30 <i>Ver. 00</i>	3AC 400 V Pr1.31 <i>Ver. 00</i>	3AC+N 230 V Pr1.32 <i>Ver. 00</i>	3AC 400 V Pr1.33 <i>Ver. 00</i>	3AC+N 230 V Pr1.34 <i>Ver. 00</i>	3AC+N 230 V Pr1.36 <i>Ver. 00</i>
Counter	Alarm	Last reset							
		Number							
		List							
		Time sum							
		Reset							
	Standby	Last reset							
		Number							
		List							
		Time sum							
	Relay	Reset							
		Last reset							
		List							
		Reset							

15.8 NRS 097-2-1:2010 + NRS 097-2-1:2024 + AS4777,2

When changing the program, all parameters are reset.



Main menu	Sub menu	Parameter menu	My Data	 South Africa NRS 097-2-1:						 Australia AS4777,2	
				2010		A1 + A2		A3			
				3AC+N 230 V	3AC 400 V	3AC+N 230 V	3AC 400 V	3AC+N 230 V	3AC 400 V	3AC+N 240 V	
				Pr1.40 Ver. 00	Pr1.41 Ver. 00	Pr1.50 Ver. 00	Pr1.51 Ver. 00	Pr1.52 Ver. 00	Pr1.53 Ver. 00	Pr1.42 Ver. 00	
Mains connection		Connection		3AC-N	3AC	3AC-N	3AC	3AC-N	3AC	3AC-N	
		Nominal voltage [V]		230,0	400,0	230,0	230,0	230,0	230,0	240,0	
		Coupling device		no	no	no	no	no	no	no	
Switch on conditions	Voltage	Active		no	no	yes	yes	no	no	no	
		U max. [V]		250,0	435,0	253,0	438,2	250,0	434,2	255,0	
		U min. [V]		199,0	342,0	195,5	338,6	199,0	342,6	185,0	
	Frequency	Active		no	no	no	no	no	no	no	no
		F max. [Hz]		50,55	50,55	51,50	51,50	50,55	50,00	50,50	
		F min. [Hz]		48,00	48,00	47,00	47,00	48,00	49,50	48,50	
	Switch on delay	Time [s]		60	60	61	61	61	61	60	
	After alarms	Switch back		triggered	triggered	triggered	triggered	triggered	triggered	triggered	
	Short alarm	Active									
Voltage	U >> 59.S2 59>S2	Alarm active		yes	yes	yes	yes	yes	yes	no	
		Alarm on [V]		276,0	478,0	264,5	458,1	264,5	458,1	264,0	
		Alarm off [V]		273,0	475,0	260,0	454,1	260,0	454,1	259,0	
		Delay alarm on [s]		0,16	0,16	0,06	0,06	0,06	0,06	1,80	
		Delay alarm off [s]		60	60	61	61	61	61	60	
	U > 59.S1 59>S1	Alarm active		yes	yes	yes	yes	yes	yes	yes	yes
		Alarm on [V]		253,0	438,0	253,0	438,2	253,0	438,2	260,0	
		Alarm off [V]		250,0	435,0	250,0	434,2	250,0	434,2	255,0	
		Delay alarm on [s]		2,00	2,00	1,90	1,90	1,90	1,90	1,80	
		Delay alarm off [s]		60	60	61	61	61	61	60	
	UM> 59-Av	Alarm active		no	no	no	no	no	no	no	yes
		Alarm on [V]		253,0	438,0	253,0	438,2	253,0	438,2	255,0	
		Alarm off [V]		250,0	435,0	250,0	434,2	250,0	434,2	250,0	
		Delay alarm on [s]		0,10	0,10	0,10	0,10	0,10	0,10	2,00	
		Delay alarm off [s]		60	60	61	61	61	61	60	
	U < 27.S1 27<S1	Alarm active		yes	yes	yes	yes	yes	yes	yes	yes
		Alarm on [V]		196,0	339,0	195,5	338,6	195,5	338,6	180,0	
		Alarm off [V]		199,0	342,0	199,0	342,6	199,0	342,6	185,0	
		Delay alarm on [s]		10,00	10,00	9,90	9,90	9,90	9,90	1,80	
		Delay alarm off [s]		60	60	61	61	61	61	60	
	U << 27.S2 27<S2	Alarm active		yes	yes	yes	yes	yes	yes	yes	no
		Alarm on [V]		115,0	199,0	115,0	199,2	115,0	199,2	146,0	
		Alarm off [V]		117,0	201,0	117,0	203,2	117,0	203,2	151,0	
		Delay alarm on [s]		0,20	0,20	0,10	0,10	0,10	0,10	1,80	
Delay alarm off [s]			60	60	61	61	61	61	60		

Grey values can only be read (not changed) regardless of the code lock/sealing.

Main menu	Sub menu	Parameter menu	My Data	South Africa NRS 097-2-1:						Australia AS4777,2	
				2010		2024					
				3AC+N 230 V	3AC 400 V	A1 + A2 3AC+N 230 V	3AC 400 V	A3 3AC+N 230 V	3AC 400 V	3AC+N 240 V	
				Pr1.40 Ver. 00	Pr1.41 Ver. 00	Pr1.50 Ver. 00	Pr1.51 Ver. 00	Pr1.52 Ver. 00	Pr1.53 Ver. 00	Pr1.42 Ver. 00	
	U0	Alarm active		no	no	no	no	no	no	no	
	59v0	Alarm on [V]		46,0	80,0	46,0	46,0	46,0	46,0	46,0	
		Alarm off [V]		36,0	70,0	36,0	36,0	36,0	36,0	36,0	
		Delay alarm on [s]		1,50	1,50	1,50	1,50	1,50	1,50	1,50	
		Delay alarm off [s]		60	60	61	61	61	61	60	
		Display U0/UM> [s]		5,0	5,0	5,0	5,0	5,0	5,0	5,0	
Frequency	f >>	Alarm active		no	no	no	no	no	no	no	
	81.S2	Alarm on [Hz]		51,50	51,50	51,50	51,50	51,50	51,50	52,00	
	81>S2	Alarm off [Hz]		50,05	50,05	50,05	50,05	50,05	50,05	50,50	
		Delay alarm on [s]		0,10	0,10	0,10	0,10	0,10	0,10	2,00	
		Delay alarm off [s]		60	60	61	61	61	61	60	
	f >	Alarm active		yes	yes	yes	yes	yes	yes	yes	
	81.S1	Alarm on Hz		52,00	52,00	51,50	51,50	50,20	50,20	52,00	
	81>S1	Alarm off Hz		50,55	50,55	50,55	50,55	50,00	50,00	50,50	
		Delay alarm on [s]		4,00	4,00	3,90	3,90	3,90	3,90	2,00	
		Delay alarm off [s]		60	60	61	61	61	61	60	
	f <	Alarm active		yes	yes	yes	yes	yes	yes	yes	
	81.S1	Alarm on [Hz]		47,00	47,00	47,00	47,00	49,00	49,00	47,00	
	81<S1	Alarm off [Hz]		48,00	48,00	48,00	48,00	49,50	49,50	48,50	
		Delay alarm on [s]		0,20	0,20	0,10	0,10	0,10	0,10	1,80	
		Delay alarm off [s]		60	60	61	61	61	61	60	
	f <<	Alarm active		no	no	no	no	no	no	no	
	81.S2	Alarm on [Hz]		47,50	47,50	47,50	47,50	47,50	47,50	47,00	
	81<S2	Alarm off [Hz]		48,50	48,50	48,50	48,50	48,50	48,50	48,50	
		Delay alarm on [s]		0,10	0,10	0,10	0,10	0,10	0,10	1,80	
		Delay alarm off [s]		60	60	61	61	61	61	60	
	f/U< protect	Alarm active		no	no	no	no	no	no	no	
		U< Limit [V]		46,0	46,0	46,0	46,0	46,0	46,0	46,0	
	Frequency-range	Alarm active									
		Alarm U< on [V]									
Alarm U< off [V]											
Alarm 3U0 on [V]											
Alarm 3U0 off [V]											
Delay alarm on [s]											
	Delay alarm off [s]										
Vector shift	Alarm active		no	no	no	no	no	no	no	yes	
	VSR deg °		10,0	10,0	10,0	10,0	10,0	10,0	10,0	8,0	
	Delay alarm off [s]		3	3	3	3	3	3	3	3	
	suppression [s]		3	3	3	3	3	3	3	2	
ROCOF	Alarm active		no	no	yes	yes	no	no	yes		
	df / dt		0,800	0,800	1,500	1,500	0,800	0,800	1,000		
	Periods		20	20	25	25	20	20	20		
	Delay alarm on [s]		0,10	0,10	1,90	1,90	0,10	0,10	1,00		
	Delay alarm off [s]		60	60	60	60	61	61	60		
Feed-back	Feedback at		off	off	off	off	off	off	off		
	Time for feedb. [s]		1,5	1,5	1,5	1,5	1,5	1,5	1,5		
	Reclosing attempts		2	2	2	2	2	2	2		
	Reclosing Time [s]		5	5	5	5	5	5	5		

Main menu	Sub menu	Parameter menu	My Data	South Africa NRS 097-2-1:						Australia AS4777,2
				2010		2024		A3		
				3AC+N 230 V	3AC 400 V	A1 + A2 3AC+N 230 V	3AC 400 V	3AC+N 230 V	3AC 400 V	3AC+N 240 V
				Pr1.40 Ver. 00	Pr1.41 Ver. 00	Pr1.50 Ver. 00	Pr1.51 Ver. 00	Pr1.52 Ver. 00	Pr1.53 Ver. 00	Pr1.42 Ver. 00
Relay K3		Relay function		life-contact	life-contact	life-contact	life-contact	life-contact	life-contact	life-contact
		K3 pulse [s]		2,0	2,0	2,0	2,0	2,0	2,0	2,0
		K3 after K1+K2 [s]		0,1	0,1	0,1	0,1	0,1	0,1	0,1
Digital Inputs	E1-E2	Type		normally open	normally open	normally open	normally open	normally open	normally open	normally open
		Function		System off	System off	System off	System off	System off	System off	System off
	In1	Type		normally open	normally open	normally open	normally open	normally open	normally open	normally open
		Function		Y1 inactive	Y1 inactive	Y1 inactive	Y1 inactive	Y1 inactive	Y1 inactive	Y1 inactive
		Sw.-on delay [s]								
	In2	Type		normally open	normally open	normally open	normally open	normally open	normally open	normally open
		Function		Y2 inactive	Y2 inactive	Y2 inactive	Y2 inactive	Y2 inactive	Y2 inactive	Y2 inactive
		Sw.-on delay [s]								
	In3	Type		normally open	normally open	normally open	normally open	normally open	normally open	normally open
		Function		Y1+Y2 inactive	Y1+Y2 inactive	Y1+Y2 inactive	Y1+Y2 inactive	Y1+Y2 inactive	Y1+Y2 inactive	Y1+Y2 inactive
		Sw.-on delay [s]								
	Network		Network			on	on	on	on	
		DHCP								
		IP address								
		Subnet mask								
		Gateway								
		DNS server								
		MAC address								
Settings		Language								
		Date								
		Time								
		Display interval [s]		0,5	0,5	0,5	0,5	0,5	0,5	
		Brightness [%]		50	50	50	50	50	50	
		Dimming time [s]		300	300	300	300	300	300	
		Factory setting		-	-	-	-	-	-	
		Restart		-	-	-	-	-	-	
		Code lock / Pin		off / 504	off / 504	off / 504	off / 504	off / 504	off / 504	
Test/simulation		Relay								
		Simulation								
		Test K1/K2								
		switch back time [s]		60	60	61	61	61	61	
Info		Firmware version								
		Serial number								
		Operating hours								
		Comment								

- Orange values -> only visible, if „function“ = „DI Release“ is set



Main menu	Sub menu	Parameter menu	My Data	 South Africa NRS 097-2-1:						 Australia AS4777,2
				2010		2024				
				3AC+N 230 V	3AC 400 V	A1 + A2		A3		3AC+N 240 V
				Pr1.40 <i>Ver. 00</i>	Pr1.41 <i>Ver. 00</i>	Pr1.50 <i>Ver. 00</i>	Pr1.51 <i>Ver. 00</i>	Pr1.52 <i>Ver. 00</i>	Pr1.53 <i>Ver. 00</i>	Pr1.42 <i>Ver. 00</i>
Counter	Alarm	Last reset								
		Number								
		List								
		Time sum								
		Reset								
	Standby	Last reset								
		Number								
		List								
		Time sum								
		Reset								
	Relay	Last reset								
		List								
Reset										

15.9 RD647/2020 + Western/Eastern Denmark DK 1/DK 2 Typ A + B + C + D

When changing the program, all parameters are reset.

Main menu	Sub menu	Parameter menu	My Data	Spain RD647/2020		Western Denmark DK 1		Eastern Denmark DK 2		Denmark
				3AC+N 230 V	3AC 400 V	Typ A+B 3AC+N 230 V	Typ C 3AC+N 230 V	Typ A+B 3AC+N 230 V	Typ C 3AC+N 230 V	Typ D 3AC+N 230 V
				Pr1.44 Ver. 00	Pr1.45 Ver. 00	Pr1.55 Ver. 00	Pr1.56 Ver. 00	Pr1.57 Ver. 00	Pr1.58 Ver. 00	Pr1.59 Ver. 00
Mains connection		Connection		3AC-N	3AC	3AC-N	3AC-N	3AC-N	3AC-N	3AC-N
		Nominal voltage [V]		230,0	400,0	230,0	230,0	230,0	230,0	230,0
		Coupling device		no	no	no	no	no	no	no
Switch on conditions	Voltage	Active		no	no	yes	yes	yes	yes	yes
		U max. [V]		250,0	435,0	253,0	253,0	253,0	253,0	253,0
		U min. [V]		198,5	345,0	195,5	207,0	195,5	207,0	207,0
	Frequency	Active		no	no	yes	yes	yes	yes	yes
		F max. [Hz]		50,00	50,00	50,20	50,20	50,50	50,50	51,50
		F min. [Hz]		49,00	49,00	47,50	47,50	47,50	47,50	47,50
	Switch on delay	Time [s]		180	180	180	180	180	180	180
	After alarms	Switch back		triggered	triggered	triggered	triggered	triggered	triggered	triggered
Short alarm	Active									
Voltage	U >> 59.S2 59>S2	Alarm active		yes	yes	yes	yes	yes	yes	yes
		Alarm on [V]		264,5	460,0	264,5	264,5	264,5	264,5	264,5
		Alarm off [V]		261,5	455,0	251,9	251,9	251,9	251,9	251,9
		Delay alarm on [s]		0,10	0,10	0,10	0,05	0,10	0,05	0,05
		Delay alarm off [s]		180	180	180	180	180	180	180
	U > 59.S1 59>S1	Alarm active		yes	yes	yes	yes	yes	yes	yes
		Alarm on [V]		253,0	440,0	253,0	253,0	253,0	253,0	253,0
		Alarm off [V]		250,0	435,0	251,9	251,9	251,9	251,9	251,9
		Delay alarm on [s]		1,40	1,40	59,90	59,90	59,90	59,90	59,90
		Delay alarm off [s]		180	180	180	180	180	180	180
	UM> 59-Av	Alarm active		no	no	no	no	no	no	no
		Alarm on [V]		253,0	440,0	253,0	253,0	253,0	253,0	253,0
		Alarm off [V]		250,0	345,0	251,9	251,9	251,9	251,9	251,9
		Delay alarm on [s]		1,40	1,40	0,10	0,10	0,10	0,10	0,10
		Delay alarm off [s]		180	180	180	180	180	180	180
	U < 27.S1 27<S1	Alarm active		yes	yes	yes	yes	yes	yes	yes
		Alarm on [V]		195,5	340,0	195,5	207,0	195,5	207,0	207,0
		Alarm off [V]		198,5	345,0	196,7	208,2	196,7	208,2	208,2
		Delay alarm on [s]		1,51	1,53	49,90	59,90	49,90	59,90	59,90
		Delay alarm off [s]		180	180	180	180	180	180	180
U << 27.S2 27<S2	Alarm active		no	no	yes	yes	yes	yes	yes	
	Alarm on [V]		195,5	340,0	184,0	184,0	184,0	184,0	184,0	
	Alarm off [V]		198,5	345,0	196,7	208,2	196,7	208,2	208,2	
	Delay alarm on [s]		1,50	1,50	0,10	0,10	0,10	0,10	0,10	
	Delay alarm off [s]		180	180	180	180	180	180	180	

Grey values can only be read (not changed) regardless of the code lock/sealing.

Main menu	Sub menu	Parameter menu	My Data	 Spain RD647/2020		 Western Denmark DK 1		 Eastern Denmark DK 2		Denmark	
				3AC+N 230 V	3AC 400 V	Typ A+B 3AC+N 230 V	Typ C 3AC+N 230 V	Typ A+B 3AC+N 230 V	Typ C 3AC+N 230 V	Typ D 3AC+N 230 V	
				Pr1.44 Ver. 00	Pr1.45 Ver. 00	Pr1.55 Ver. 00	Pr1.56 Ver. 00	Pr1.57 Ver. 00	Pr1.58 Ver. 00	Pr1.59 Ver. 00	
	U0 59v0	Alarm active		no	no	no	no	no	no	no	
		Alarm on [V]		46,0	46,0	46,0	46,0	46,0	46,0	46,0	46,0
		Alarm off [V]		36,0	36,0	36,0	36,0	36,0	36,0	36,0	36,0
		Delay alarm on [s]		1,50	1,50	1,50	1,50	1,50	1,50	1,50	1,50
		Delay alarm off [s]		180	180	180	180	180	180	180	180
		Display U0/UM> [s]		5,0	5,0	5,0	5,0	5,0	5,0	5,0	5,0
Frequency	f >> 81.S2 81>S2	Alarm active		no	no	no	no	no	no	no	
		Alarm on [Hz]		51,00	51,00	51,50	51,50	51,50	51,50	51,50	51,50
		Alarm off [Hz]		50,00	50,00	50,20	50,20	50,20	50,20	50,20	50,20
		Delay alarm on [s]		0,50	0,50	0,10	0,10	0,10	0,10	0,10	0,10
		Delay alarm off [s]		180	180	180	180	180	180	180	180
	f > 81.S1 81>S1	Alarm active		yes	yes	yes	yes	yes	yes	yes	yes
		Alarm on Hz		51,00	51,00	51,50	51,50	51,50	51,50	51,50	51,50
		Alarm off Hz		50,00	50,00	50,20	50,20	50,50	50,50	50,50	50,50
		Delay alarm on [s]		0,40	0,40	0,10	0,10	0,10	0,10	0,10	0,10
		Delay alarm off [s]		180	180	180	180	180	180	180	180
	f < 81.S1 81<S1	Alarm active		yes	yes	yes	yes	yes	yes	yes	yes
		Alarm on [Hz]		48,00	48,00	47,50	47,50	47,50	47,50	47,50	47,50
		Alarm off [Hz]		49,00	49,00	47,60	47,60	47,60	47,60	47,60	47,60
		Delay alarm on [s]		3,05	3,05	0,10	0,10	0,10	0,10	0,10	0,10
		Delay alarm off [s]		180	180	180	180	180	180	180	180
	f << 81.S2 81<S2	Alarm active		no	no	no	no	no	no	no	no
		Alarm on [Hz]		48,00	48,00	47,50	47,50	47,50	47,50	47,50	47,50
		Alarm off [Hz]		49,00	49,00	47,60	47,60	47,60	47,60	47,60	47,60
		Delay alarm on [s]		3,00	3,00	0,10	0,10	0,10	0,10	0,10	0,10
		Delay alarm off [s]		180	180	180	180	180	180	180	180
	f/U< protect	Alarm active		no	no	no	no	no	no	no	no
		U< Limit [V]		46,0	46,0	46,0	46,0	46,0	46,0	46,0	46,0
	Frequency-range	Alarm active									
		Alarm U< on [V]									
Alarm U< off [V]											
Alarm 3U0 on [V]											
Alarm 3U0 off [V]											
Delay alarm on [s]											
Delay alarm off [s]											
Vector shift	Alarm active		no	no	no	no	no	no	no	no	
	VSR deg °		10,0	10,0	10,0	10,0	10,0	10,0	10,0	10,0	
	Delay alarm off [s]		3	3	3	3	3	3	3	3	
	suppression [s]		2	2	3	3	3	3	3	3	
ROCOF	Alarm active		no	no	no	no	no	no	no	no	
	df / dt		1,000	1,000	2,500	2,500	2,500	2,500	2,500	2,500	
	Periods		20	20	10	10	10	10	10	10	
	Delay alarm on [s]		1,00	1,00	0,07	0,07	0,07	0,07	0,07	0,07	
	Delay alarm off [s]		180	180	180	180	180	180	180	180	
Feed-back	Feedback at		off	off	off	off	off	off	off	off	
	Time for feedb. [s]		1,5	1,5	1,5	1,5	1,5	1,5	1,5	1,5	
	Reclosing attempts		2	2	2	2	2	2	2	2	
	Reclosing Time [s]		5	5	5	5	5	5	5	5	

Main menu	Sub menu	Parameter menu	Meine Daten	Spain RD647/2020		Western Denmark DK 1		Eastern Denmark DK 2		Denmark
				3AC+N 230 V	3AC 400 V	Typ A+B 3AC+N 230 V	Typ C 3AC+N 230 V	Typ A+B 3AC+N 230 V	Typ C 3AC+N 230 V	Typ D 3AC+N 230 V
				Pr1.44 Ver. 00	Pr1.45 Ver. 00	Pr1.55 Ver. 00	Pr1.56 Ver. 00	Pr1.57 Ver. 00	Pr1.58 Ver. 00	Pr1.59 Ver. 00
Relay K3		Relay function		life-contact	life-contact	life-contact	life-contact	life-contact	life-contact	life-contact
		K3 pulse [s]		2,0	2,0	2,0	2,0	2,0	2,0	2,0
		K3 after K1+K2 [s]		0,1	0,1	0,1	0,1	0,1	0,1	0,1
Digital Inputs	E1-E2	Type		normally open	normally open	normally open	normally open	normally open	normally open	normally open
		Function		System off	System off	System off	System off	System off	System off	System off
	In1	Type		normally open	normally open	normally open	normally open	normally open	normally open	normally open
		Function		Y1 inactive	Y1 inactive	Y1 inactive	Y1 inactive	Y1 inactive	Y1 inactive	Y1 inactive
		Sw.-on delay [s]								
	In2	Type		normally open	normally open	normally open	normally open	normally open	normally open	normally open
		Function		Y2 inactive	Y2 inactive	Y2 inactive	Y2 inactive	Y2 inactive	Y2 inactive	Y2 inactive
		Sw.-on delay [s]								
	In3	Type		normally open	normally open	normally open	normally open	normally open	normally open	normally open
		Function		Y1+Y2 inactive	Y1+Y2 inactive	Y1+Y2 inactive	Y1+Y2 inactive	Y1+Y2 inactive	Y1+Y2 inactive	Y1+Y2 inactive
		Sw.-on delay [s]								
	Network		Network		on	on	on	on	on	on
		DHCP								
		IP address								
		Subnet mask								
		Gateway								
		DNS server								
		MAC address								
Settings		Language								
		Date								
		Time								
		Display interval [s]		0,5	0,5	0,5	0,5	0,5	0,5	0,5
		Brightness [%]		50	50	50	50	50	50	50
		Dimming time [s]		300	300	300	300	300	300	300
		Factory setting		-	-	-	-	-	-	-
		Restart		-	-	-	-	-	-	-
		Code lock / Pin		off / 504	off / 504	off / 504	off / 504	off / 504	off / 504	off / 504
Test/ simulation		Relay								
		Simulation								
		Test K1/K2								
		switch back time [s]		180	180	180	180	180	180	180
Info		Firmware version								
		Serial number								
		Operating hours								
		Comment								

- Orange values -> only visible, if „function“ = „DI Release“ is set

Main menu	Sub menu	Parameter menu	My Data	Spain RD647/2020		Western Denmark DK 1		Eastern Denmark DK 2		Denmark
				3AC+N 230 V	3AC 400 V	Typ A+B 3AC+N 230 V	Typ C 3AC+N 230 V	Typ A+B 3AC+N 230 V	Typ C 3AC+N 230 V	Typ D 3AC+N 230 V
				Pr1.44 <i>Ver. 00</i>	Pr1.45 <i>Ver. 00</i>	Pr1.55 <i>Ver. 00</i>	Pr1.56 <i>Ver. 00</i>	Pr1.57 <i>Ver. 00</i>	Pr1.58 <i>Ver. 00</i>	Pr1.59 <i>Ver. 00</i>
Counter	Alarm	Last reset								
		Number								
		List								
		Time sum								
		Reset								
	Standby	Last reset								
		Number								
		List								
		Time sum								
		Reset								
	Relay	Last reset								
		List								
		Reset								

15.10 With coupling device VG1200 - VDE-AR-N 4110:2018-11 + VDE-AR-N 4110:2023-09

When changing the program, all parameters are reset.

Main menu	Sub menu	Parameter menu	My Data	 Germany VDE-AR-N 4110:2018 + 4110:2023-09				
				3AC 690 V	3AC 800 V	3AC 1000 V	3AC+N 400 V	3AC+N 460 V
				Pr2.00 Ver. 02	Pr2.01 Ver. 02	Pr2.02 Ver. 02	Pr2.10 Ver. 02	Pr2.11 Ver. 02
Mains connection		Connection		3AC	3AC	3AC	3AC-N	3AC-N
		Nominal voltage [V]		690	800	1000	400	460
		Coupling device		yes	yes	yes	yes	yes
Switch on conditions	Voltage	Active		yes	yes	yes	yes	yes
		U max. [V]		759	880	1100	440	506
		U min. [V]		621	720	900	360	414
	Frequency	Active		yes	yes	yes	yes	yes
		F max. [Hz]		50,20	50,20	50,20	50,20	50,20
		F min. [Hz]		47,50	47,50	47,50	47,50	47,50
	Switch on delay	Time [s]		60	60	60	60	60
	After alarms	Switch back		all F+U<+U<<	all F+U<+U<<	all F+U<+U<<	all F+U<+U<<	all F+U<+U<<
Short alarm	Active							
Voltage	U >> 59.S2 59>S2	Alarm active		yes	yes	yes	yes	yes
		Alarm on [V]		859	996	1245	498	573
		Alarm off [V]		854	990	1238	495	569
		Delay alarm on [s]		0,10	0,10	0,10	0,10	0,10
		Delay alarm off [s]		60	60	60	60	60
	U > 59.S1 59>S1	Alarm active		no	no	no	no	no
		Alarm on [V]		742	860	1075	430	495
		Alarm off [V]		737	854	1067	427	491
		Delay alarm on [s]		60,00	60,00	60,00	60,00	60,00
		Delay alarm off [s]		60	60	60	60	60
	UM> 59-Av	Alarm active		no	no	no	no	no
		Alarm on [V]		756	876	1095	438	504
		Alarm off [V]		751	870	1088	435	501
		Delay alarm on [s]		0,10	0,10	0,10	0,10	0,10
		Delay alarm off [s]		60	60	60	60	60
	U < 27.S1 27<S1	Alarm active		yes	yes	yes	yes	yes
		Alarm on [V]		549	636	795	318	366
		Alarm off [V]		654	758	947	379	436
		Delay alarm on [s]		1,00	1,00	1,00	1,00	1,00
		Delay alarm off [s]		60	60	60	60	60
U << 27.S2 27<S2	Alarm active		yes	yes	yes	yes	yes	
	Alarm on [V]		309	358	448	179	206	
	Alarm off [V]		619	718	898	359	413	
	Delay alarm on [s]		0,30	0,30	0,30	0,30	0,30	
	Delay alarm off [s]		60	60	60	60	60	

Grey values can only be read (not changed) regardless of the code lock/sealing.



Germany

VDE-AR-N 4110:2018 + 4110:2023-09

Main menu	Sub menu	Parameter menu	My Data	3AC 690 V	3AC 800 V	3AC 1000 V	3AC+N 400 V	3AC+N 460 V
				Pr2.00 Ver. 02	Pr2.01 Ver. 02	Pr2.02 Ver. 02	Pr2.10 Ver. 02	Pr2.11 Ver. 02
	U0 59v0	Alarm active					no	no
		Alarm on [V]					80	92
		Alarm off [V]					62	72
		Delay alarm on [s]					1,50	1,50
		Delay alarm off [s]					60	60
		Display U0/UM> [s]					5,0	5,0
Frequency	f >> 81.S2 81>S2	Alarm active		yes	yes	yes	yes	yes
		Alarm on [Hz]		52,50	52,50	52,50	52,50	52,50
		Alarm off [Hz]		50,10	50,10	50,10	50,10	50,10
		Delay alarm on [s]		0,10	0,10	0,10	0,10	0,10
		Delay alarm off [s]		60	60	60	60	60
	f > 81.S1 81>S1	Alarm active		yes	yes	yes	yes	yes
		Alarm on Hz		51,50	51,50	51,50	51,50	51,50
		Alarm off Hz		50,10	50,10	50,10	50,10	50,10
		Delay alarm on [s]		5,00	5,00	5,00	5,00	5,00
		Delay alarm off [s]		60	60	60	60	60
	f < 81.S1 81<S1	Alarm active		yes	yes	yes	yes	yes
		Alarm on [Hz]		47,50	47,50	47,50	47,50	47,50
		Alarm off [Hz]		49,90	49,90	49,90	49,90	49,90
		Delay alarm on [s]		0,10	0,10	0,10	0,10	0,10
		Delay alarm off [s]		60	60	60	60	60
	f << 81.S2 81<S2	Alarm active		no	no	no	no	no
		Alarm on [Hz]		47,50	47,50	47,50	47,50	47,50
		Alarm off [Hz]		49,90	49,90	49,90	49,90	49,90
		Delay alarm on [s]		0,10	0,10	0,10	0,10	0,10
		Delay alarm off [s]		60	60	60	60	60
f/U< protect	Alarm active		no	no	no	no	no	
	U< Limit [V]		80	92	115	46	53	
Frequency-range	Alarm active							
	Alarm U< on [V]							
	Alarm U< off [V]							
	Alarm 3U0 on [V]							
	Alarm 3U0 off [V]							
	Delay alarm on [s]							
	Delay alarm off [s]							
Vector shift	Alarm active		no	no	no	no	no	
	VSR deg °		10,0	10,0	10,0	10,0	10,0	
	Delay alarm off [s]		3	3	3	3	3	
	suppression [s]		3	3	3	3	3	
ROCOF	Alarm active		no	no	no	no	no	
	df / dt		2,000	2,000	2,000	2,000	2,000	
	Periods		20	20	20	20	20	
	Delay alarm on [s]		0,10	0,10	0,10	0,10	0,10	
	Delay alarm off [s]		60	60	60	60	60	
Feed-back	Feedback at		off	off	off	off	off	
	Time for feedb. [s]		1,5	1,5	1,5	1,5	1,5	
	Reclosing attempts		2	2	2	2	2	
	Reclosing Time [s]		5	5	5	5	5	



Germany

VDE-AR-N 4110:2018 + 4110:2023-09

Main menu	Sub menu	Parameter menu	My Data	3AC 690 V	3AC 800 V	3AC 1000 V	3AC+N 400 V	3AC+N 460 V
				Pr2.00	Pr2.01	Pr2.02	Pr2.10	Pr2.11
				Ver. 02	Ver. 02	Ver. 02	Ver. 02	Ver. 02
Relay K3		Relay function		life- contact	life- contact	life- contact	life- contact	life- contact
		K3 pulse [s]		2,0	2,0	2,0	2,0	2,0
		K3 after K1+K2 [s]		0,1	0,1	0,1	0,1	0,1
Digital Inputs	E1-E2	Type		normally open	normally open	normally open	normally open	normally open
		Function		System off	System off	System off	System off	System off
	In1	Type		normally open	normally open	normally open	normally open	normally open
		Function		Y1 inactive	Y1 inactive	Y1 inactive	Y1 inactive	Y1 inactive
		Sw.-on delay [s]						
	In2	Type		normally open	normally open	normally open	normally open	normally open
		Function		Y2 inactive	Y2 inactive	Y2 inactive	Y2 inactive	Y2 inactive
		Sw.-on delay [s]						
	In3	Type		normally open	normally open	normally open	normally open	normally open
		Function		Y1+Y2 inactive	Y1+Y2 inactive	Y1+Y2 inactive	Y1+Y2 inactive	Y1+Y2 inactive
		Sw.-on delay [s]						
	Network		Network		on	on	on	on
DHCP								
IP address								
Subnet mask								
Gateway								
DNS server								
MAC address								
Settings		Language						
		Date						
		Time						
		Display interval [s]		0,5	0,5	0,5	0,5	0,5
		Brightness [%]		50	50	50	50	50
		Dimming time [s]		300	300	300	300	300
		Factory setting		-	-	-	-	-
		Restart		-	-	-	-	-
		Code lock / Pin		off / 504	off / 504	off / 504	off / 504	off / 504
Test/ simula- tion		Relay						
		Simulation						
		Test K1/K2						
		switch back time [s]		60	60	60	60	60
Info		Firmware version						
		Serial number						
		Operating hours						
		Comment						

- Orange values -> only visible, if „function“ = „DI Release“ is set



Germany

VDE-AR-N 4110:2018 + 4110:2023-09

Main menu	Sub menu	Parameter menu	My Data	3AC 690 V	3AC 800 V	3AC 1000 V	3AC+N 400 V	3AC+N 460 V
				Pr2.00 <i>Ver. 02</i>	Pr2.01 <i>Ver. 02</i>	Pr2.02 <i>Ver. 02</i>	Pr2.10 <i>Ver. 02</i>	Pr2.11 <i>Ver. 02</i>
Counter	Alarm	Last reset						
		Number						
		List						
		Time sum						
		Reset						
	Standby	Last reset						
		Number						
		List						
		Time sum						
		Reset						
	Relay	Last reset						
		List						
		Reset						

15.11 With coupling device VG1200 - VDE-AR-N 4120:2018-11

When changing the program, all parameters are reset.

				 Germany VDE-AR-N 4120:2018		
Main menu	Sub menu	Parameter menu	My Data	3AC 480 V	3AC 690 V	3AC 800 V
				Pr2.30 Ver. 00	Pr2.31 Ver. 00	Pr2.32 Ver. 00
Mains connection		Connection		3AC	3AC	3AC
		Nominal voltage [V]		480	690	800
		Coupling device		yes	yes	yes
Switch on conditions	Voltage	Active		no	no	no
		U max. [V]		595	857	995
		U min. [V]		456	656	760
	Frequency	Active		no	no	no
		F max. [Hz]		50,10	50,10	50,10
		F min. [Hz]		49,90	49,90	49,90
	Switch on delay	Time [s]		0	0	0
	After alarms	Switch back		all F+U<+U<<	all F+U<+U<<	all F+U<+U<<
Short alarm	Active					
Voltage	U >> 59.S2 59>S2	Alarm active		yes	yes	yes
		Alarm on [V]		600	862	1000
		Alarm off [V]		595	857	995
		Delay alarm on [s]		0,10	0,10	0,10
		Delay alarm off [s]		0	0	0
	U > 59.S1 59>S1	Alarm active		no	no	no
		Alarm on [V]		528	759	880
		Alarm off [V]		523	754	875
		Delay alarm on [s]		60,00	60,00	60,00
		Delay alarm off [s]		0	0	0
	UM> 59-Av	Alarm active		no	no	no
		Alarm on [V]		528	759	880
		Alarm off [V]		523	754	875
		Delay alarm on [s]		60,00	60,00	60,00
		Delay alarm off [s]		0	0	0
	U < 27.S1 27<S1	Alarm active		yes	yes	yes
		Alarm on [V]		384	552	640
		Alarm off [V]		456	656	760
		Delay alarm on [s]		3,00	3,00	3,00
		Delay alarm off [s]		0	0	0
	U << 27.S2 27<S2	Alarm active		yes	yes	yes
		Alarm on [V]		144	207	240
		Alarm off [V]		456	656	760
		Delay alarm on [s]		1,50	1,50	1,50
Delay alarm off [s]			0	0	0	

Grey values can only be read (not changed) regardless of the code lock/sealing.

Main menu	Sub menu	Parameter menu	My Data	 Germany VDE-AR-N 4120:2018		
				3AC 480 V	3AC 690 V	3AC 800 V
				Pr2.30 Ver. 00	Pr2.31 Ver. 00	Pr2.32 Ver. 00
	U0 59v0	Alarm active				
		Alarm on [V]				
		Alarm off [V]				
		Delay alarm on [s]				
		Delay alarm off [s]				
		Display U0/UM> [s]				
Frequency	f >> 81.S2 81>S2	Alarm active		yes	yes	yes
		Alarm on [Hz]		52,50	52,50	52,50
		Alarm off [Hz]		50,10	50,10	50,10
		Delay alarm on [s]		0,09	0,09	0,09
		Delay alarm off [s]		0	0	0
	f > 81.S1 81>S1	Alarm active		no	no	no
		Alarm on Hz		51,50	51,50	51,50
		Alarm off Hz		50,10	50,10	50,10
		Delay alarm on [s]		5,00	5,00	5,00
		Delay alarm off [s]		0	0	0
	f < 81.S1 81<S1	Alarm active		yes	yes	yes
		Alarm on [Hz]		47,50	47,50	47,50
		Alarm off [Hz]		49,90	49,90	49,90
		Delay alarm on [s]		0,09	0,09	0,09
		Delay alarm off [s]		0	0	0
	f << 81.S2 81<S2	Alarm active		no	no	no
		Alarm on [Hz]		47,50	47,50	47,50
		Alarm off [Hz]		49,90	49,90	49,90
		Delay alarm on [s]		0,09	0,09	0,09
		Delay alarm off [s]		0	0	0
	f/U< protect	Alarm active		no	no	no
		U< Limit [V]		80	80	80
	Frequency-range	Alarm active				
		Alarm U< on [V]				
Alarm U< off [V]						
Alarm 3U0 on [V]						
Alarm 3U0 off [V]						
Delay alarm on [s]						
Delay alarm off [s]						
Vector shift	Alarm active		no	no	no	
	VSR deg °		10,0	10,0	10,0	
	Delay alarm off [s]		3	3	3	
	suppression [s]		3	3	3	
ROCOF	Alarm active		no	no	no	
	df / dt		2,000	2,000	2,000	
	Periods		20	20	20	
	Delay alarm on [s]		0,10	0,10	0,10	
	Delay alarm off [s]		0	0	0	
Feed-back	Feedback at		off	off	off	
	Time for feedb. [s]		1,5	1,5	1,5	
	Reclosing attempts		2	2	2	
	Reclosing Time [s]		5	5	5	

Main menu	Sub menu	Parameter menu	My Data	 Germany VDE-AR-N 4120:2018		
				3AC 480 V Pr2.30 Ver. 00	3AC 690 V Pr2.31 Ver. 00	3AC 800 V Pr2.32 Ver. 00
Relay K3		Relay function		life- contact	life- contact	life- contact
		K3 pulse [s]		2,0	2,0	2,0
		K3 after K1+K2 [s]		0,1	0,1	0,1
Digital Inputs	E1-E2	Type		normally open	normally open	normally open
		Function		System off	System off	System off
	In1	Type		normally open	normally open	normally open
		Function		DI Release	DI Release	DI Release
		Sw.-on delay [s]				
	In2	Type		normally open	normally open	normally open
		Function		Y2 inactive	Y2 inactive	Y2 inactive
		Sw.-on delay [s]				
	In3	Type		normally open	normally open	normally open
		Function		Y1+Y2 inactive	Y1+Y2 inactive	Y1+Y2 inactive
		Sw.-on delay [s]				
	Network		Network			
		DHCP		on		on
		IP address				
		Subnet mask				
		Gateway				
		DNS server				
		MAC address				
		Language				
Settings		Date				
		Time				
		Display interval [s]				
		Brightness [%]		0,5	0,5	0,5
		Dimming time [s]		50	50	50
		Factory setting		300	300	300
		Restart		-	-	-
		Code lock / Pin		-	-	-
		Relay		off / 504	off / 504	off / 504
Test/ simula- tion		Simulation				
		Test K1/K2				
		switch back time [s]				
		Firmware version		0	0	0
Info		Serial number				
		Operating hours				
		Comment				
		Kommentar				

Main menu	Sub menu	Parameter menu	My Data	 Germany VDE-AR-N 4120:2018		
				3AC 480 V Pr2.30 <i>Ver. 00</i>	3AC 690 V Pr2.31 <i>Ver. 00</i>	3AC 800 V Pr2.32 <i>Ver. 00</i>
Counter	Alarm	Last reset				
		Number				
		List				
		Time sum				
		Reset				
	Standby	Last reset				
		Number				
		List				
		Time sum				
		Reset				
	Relay	Last reset				
		List				
		Reset				

15.12 With coupling device VG1200 - VDE-AR-N 4130:2018-11

When changing the program, all parameters are reset.

				 Germany VDE-AR-N 4130:2018		
Main menu	Sub menu	Parameter menu	My Data	3AC 480 V	3AC 690 V	3AC 800 V
				Pr2.20 Ver. 00	Pr2.21 Ver. 00	Pr2.22 Ver. 00
Mains connection		Connection		3AC	3AC	3AC
		Nominal voltage [V]		480	690	800
		Coupling device		yes	yes	yes
Switch on conditions	Voltage	Active		no	no	no
		U max. [V]		595	857	995
		U min. [V]		456	656	760
	Frequency	Active		no	no	no
		F max. [Hz]		50,10	50,10	50,10
		F min. [Hz]		49,90	49,90	49,90
	Switch on delay	Time [s]		0	0	0
	After alarms	Switch back		all F+U<+U<<	all F+U<+U<<	all F+U<+U<<
Short alarm	Active					
Voltage	U >> 59.S2 59>S2	Alarm active		yes	yes	yes
		Alarm on [V]		600	862	1000
		Alarm off [V]		595	857	995
		Delay alarm on [s]		0,10	0,10	0,10
		Delay alarm off [s]		0	0	0
	U > 59.S1 59>S1	Alarm active		no	no	no
		Alarm on [V]		528	759	880
		Alarm off [V]		523	754	875
		Delay alarm on [s]		60,00	60,00	60,00
		Delay alarm off [s]		0	0	0
	UM> 59-Av	Alarm active		no	no	no
		Alarm on [V]		528	759	880
		Alarm off [V]		523	754	875
		Delay alarm on [s]		60,00	60,00	60,00
		Delay alarm off [s]		0	0	0
	U < 27.S1 27<S1	Alarm active		yes	yes	yes
		Alarm on [V]		384	552	640
		Alarm off [V]		456	656	760
		Delay alarm on [s]		3,00	3,00	3,00
		Delay alarm off [s]		0	0	0
	U << 27.S2 27<S2	Alarm active		yes	yes	yes
		Alarm on [V]		144	207	240
		Alarm off [V]		456	656	760
		Delay alarm on [s]		1,50	1,50	1,50
Delay alarm off [s]			0	0	0	

Grey values can only be read (not changed) regardless of the code lock/sealing.

Main menu	Sub menu	Parameter menu	My Data	 Germany VDE-AR-N 4130:2018		
				3AC 480 V	3AC 690 V	3AC 800 V
				Pr2.20 Ver. 00	Pr2.21 Ver. 00	Pr2.22 Ver. 00
	U0 59v0	Alarm active				
		Alarm on [V]				
		Alarm off [V]				
		Delay alarm on [s]				
		Delay alarm off [s]				
		Display U0/UM> [s]				
Frequency	f >> 81.S2 81>S2	Alarm active		yes	yes	yes
		Alarm on [Hz]		52,50	52,50	52,50
		Alarm off [Hz]		50,10	50,10	50,10
		Delay alarm on [s]		0,09	0,09	0,09
		Delay alarm off [s]		0	0	0
	f > 81.S1 81>S1	Alarm active		no	no	no
		Alarm on Hz		51,50	51,50	51,50
		Alarm off Hz		50,10	50,10	50,10
		Delay alarm on [s]		5,00	5,00	5,00
		Delay alarm off [s]		0	0	0
	f < 81.S1 81<S1	Alarm active		yes	yes	yes
		Alarm on [Hz]		47,50	47,50	47,50
		Alarm off [Hz]		49,90	49,90	49,90
		Delay alarm on [s]		0,09	0,09	0,09
		Delay alarm off [s]		0	0	0
	f << 81.S2 81<S2	Alarm active		no	no	no
		Alarm on [Hz]		47,50	47,50	47,50
		Alarm off [Hz]		49,90	49,90	49,90
		Delay alarm on [s]		0,09	0,09	0,09
		Delay alarm off [s]		0	0	0
	f/U< protect	Alarm active		no	no	no
		U< Limit [V]		80	80	80
	Frequency-range	Alarm active				
		Alarm U< on [V]				
Alarm U< off [V]						
Alarm 3U0 on [V]						
Alarm 3U0 off [V]						
Delay alarm on [s]						
Delay alarm off [s]						
Vector shift	Alarm active		no	no	no	
	VSR deg °		10,0	10,0	10,0	
	Delay alarm off [s]		3	3	3	
	suppression [s]		3	3	3	
ROCOF	Alarm active		no	no	no	
	df / dt		2,000	2,000	2,000	
	Periods		20	20	20	
	Delay alarm on [s]		0,10	0,10	0,10	
	Delay alarm off [s]		0	0	0	
Feed-back	Feedback at		off	off	off	
	Time for feedb. [s]		1,5	1,5	1,5	
	Reclosing attempts		2	2	2	
	Reclosing Time [s]		5	5	5	

Main menu	Sub menu	Parameter menu	My Data	 Germany VDE-AR-N 4130:2018		
				3AC 480 V Pr2.20 Ver. 00	3AC 690 V Pr2.21 Ver. 00	3AC 800 V Pr2.22 Ver. 00
Relay K3		Relay function		life- contact	life- contact	life- contact
		K3 pulse [s]		2,0	2,0	2,0
		K3 after K1+K2 [s]		0,1	0,1	0,1
Digital Inputs	E1-E2	Type		normally open	normally open	normally open
		Function		System off	System off	System off
	In1	Type		normally open	normally open	normally open
		Function		DI Release	DI Release	DI Release
		Sw.-on delay [s]				
	In2	Type		normally open	normally open	normally open
		Function		Y2 inactive	Y2 inactive	Y2 inactive
		Sw.-on delay [s]				
	In3	Type		normally open	normally open	normally open
		Function		Y1+Y2 inactive	Y1+Y2 inactive	Y1+Y2 inactive
		Sw.-on delay [s]				
	Network		Network		on	
		DHCP				
		IP address				
		Subnet mask				
		Gateway				
		DNS server				
		MAC address				
		Language				
Settings		Date				
		Time				
		Display interval [s]				
		Brightness [%]		0,5	0,5	0,5
		Dimming time [s]		50	50	50
		Factory setting		300	300	300
		Restart		-	-	-
		Code lock / Pin		-	-	-
		Relay		off / 504	off / 504	off / 504
Test/ simula- tion		Simulation				
		Test K1/K2				
		switch back time [s]				
		Firmware version		0	0	0
Info		Serial number				
		Operating hours				
		Comment				
		Kommentar				

- Orange values -> only visible, if „function“ = „DI Release“ is set

Main menu	Sub menu	Parameter menu	My Data	 Germany VDE-AR-N 4130:2018		
				3AC 480 V Pr2.20 <i>Ver. 00</i>	3AC 690 V Pr2.21 <i>Ver. 00</i>	3AC 800 V Pr2.22 <i>Ver. 00</i>
Counter	Alarm	Last reset				
		Number				
		List				
		Time sum				
		Reset				
	Standby	Last reset				
		Number				
		List				
		Time sum				
		Reset				
	Relay	Last reset				
		List				
		Reset				