

Smart Power Supply Circuit Consolidation to simplify field operation



An advanced Power Supply system integrating a power supply, protectors, and connections changes the standard practice in the field.



In the manufacturing industries centered on the automotive sector, more production lines are becoming automated, electrified, and computerized, leading to an increase in devices and wires connected to control panels. This surely increases the workload of design teams and field operators. OMRON has updated S8AS, an integrated Power Supply that combines a DC power supply important to control panels with electronic circuit protector (CP) and terminal block functions. This all-in-one Power Supply will improve the efficiency of control panel-related electrical work from design to maintenance, helping solve problems in the field.



The system as a single unit can reduce various types of field work related to facilities and control panels.

Design **Manufacturing**

High efficiency and low heat generation enable significant space savings

Shortened wiring work without wiring between devices and by adopting the push-in connection

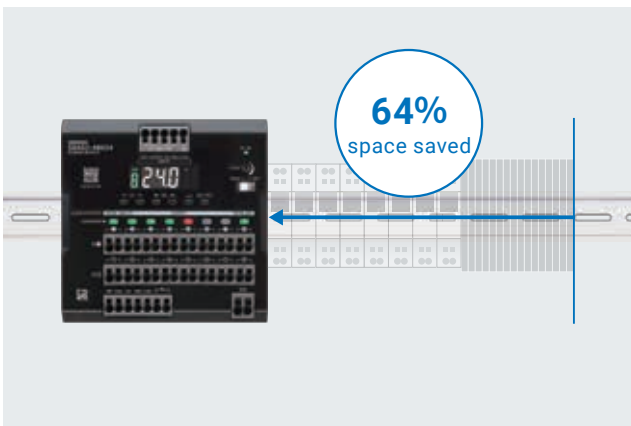

Commissioning **Maintenance**

Quick operation check of power supply circuits via display panel

Easy maintenance: Power supply lifespan is easily monitored

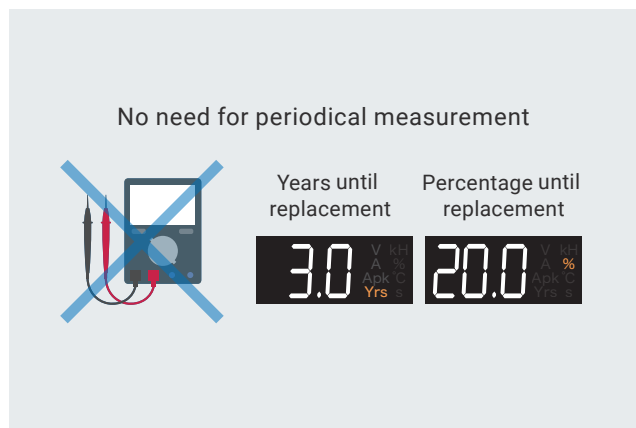
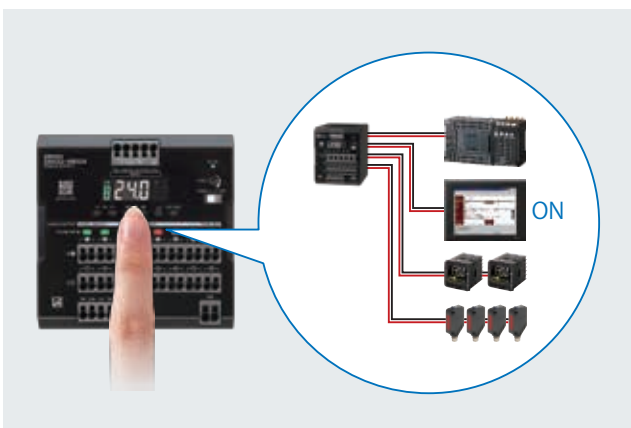

Reinforced protection for the electrical section

Stabilized power supply circuits

Environmental impact reduction

Reduced GHG emissions from control panels

Saves more space in a control panel and shortens wiring work



Struggling with optimizing device placement in a limited space and handling complex wiring

Sophisticated facilities and devices often require more power supplies and circuits, making the layout design more complex. They need a larger power capacity, more circuit protectors (CPs), and more terminal blocks, requiring more time to optimally place them in a limited space. This increases the work related to device installation and connection, putting additional pressure on assembly operators.

Layout design

Reduced system size with high-efficiency, low-heat-generation power circuits

Previous

Power Supply (480 W) x 1
+ Standard mechanical CP x 8
+ Standard terminal block x 10

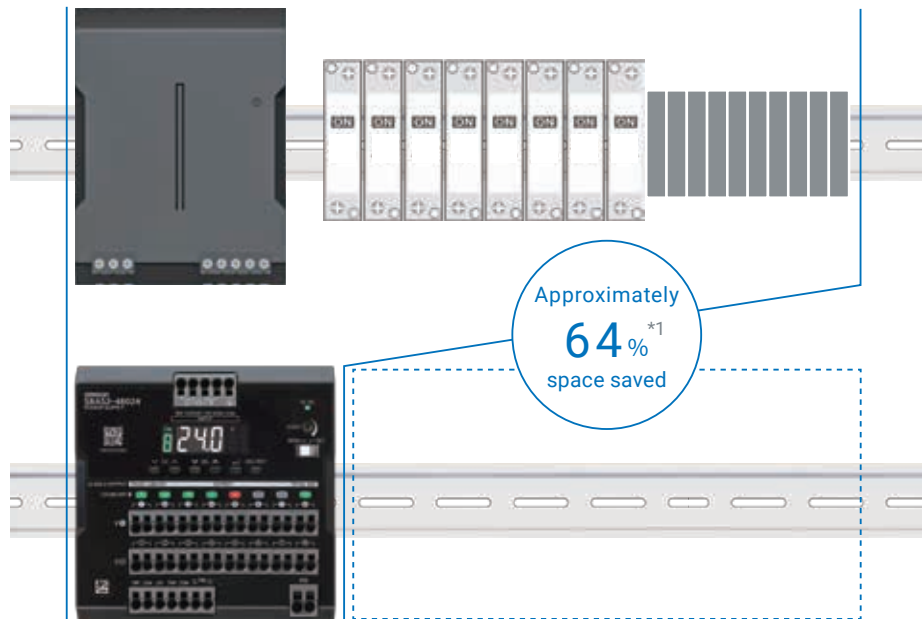

S8AS2

S8AS2 (480 W) x 1 only

*1. CP and terminal section: 8 circuits (systems)

Efforts for miniaturization

- Improving the density and efficiency to optimize the power supply and electronic circuit protectors



Improved heat dissipation by adopting an advanced device (GaN)

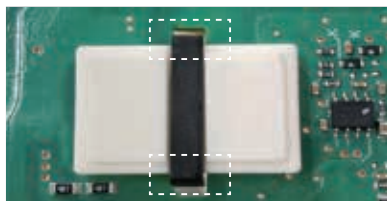

Ceramic heat dissipation design (side-lock method that does not interfere with PCB layout)

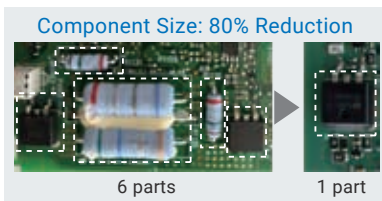

Automatic current control adopted for the CP circuit section to realize a low heat generation design

Assembly and wiring

Device consolidation to reduce the number of parts and shorten the installation and wiring work

Installation and wiring work
Approximately
1/10^{*1}

Previous Power Supply (480 W)
+ Mechanical CP + Terminal block

One Power Supply, eight CPs, and ten terminal blocks are installed in a control panel, and wiring is necessary on the load side and between the devices.

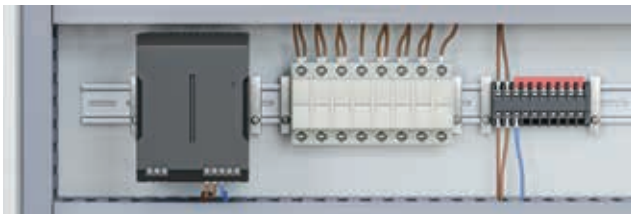

Wiring and short-circuit bars are required between devices

S8AS2 S8AS2 (480 W) only

S8AS2 is installed in a control panel, and wiring is done on the load side. **No wiring is necessary between devices.**



Integrated design eliminates the need for wiring between devices

*1. Based on our survey.

Wiring

A Push-in Plus terminal block to shorten the wiring work

wiring work
Approximately
60%^{*2}

A Push-in Plus terminal block can greatly reduce the wiring work compared with a screwed terminal block.



1. Remove the screw.
2. Insert the terminal.
3. Fasten the screw.
4. Put a check mark.
5. Further fasten the screw.



1. Insert the terminal.

Previous A screwed terminal block requires more steps to complete wiring.



With a Push-in Plus terminal block, wiring is completed in a single step.

*2. Based on our measurement data for both Push-in Plus and screwed terminal blocks.

Simple on-site troubleshooting through confirmation on the display without measurement



The power supply circuit inspection and measurement significantly increase work during commissioning and maintenance.

Sophisticated facilities and devices often require more components, which increases the work for monitoring and testing power supply circuits during facility commissioning, maintenance, device replacement, and regular inspections. This puts more pressure on field operators.



Commissioning

Complete confirmation of the power supply circuit operation for each system simply by checking the display of the S8AS2.

Switch on and off the supply voltage of each system with the button on the front of the S8AS2. The current value appears in the front display when the supply voltage is on. Use the display of the power supply system to facilitate the field operation.

Previous

Work on CPs and wiring positions one by one.

- (1) Cut the CP of the system and then resume it.
- (2) Measure the current of the system with a tester.
- (3) Measure the current of all systems with a tester.

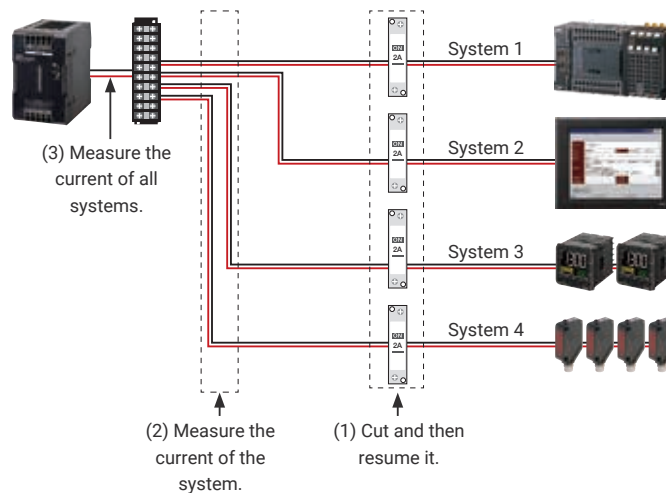

S8AS2

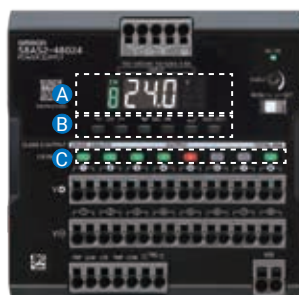

Complete by working on S8AS2 only.

- (1) With the button (C) on the front, cut the CP of the system and then resume it.
- (2) With the display (A) and the button (B) on the front, check the currents of the system and all systems.



Two-color LEDs indicate the status of individual branch systems.



-  LED: Lit in green ... Not exceeding the rated output current
-  LED: Lit in red ... Output is cut and an alarm is output.

Monitor the power circuit status with the digital display without measurement.

The digital display on the front of the S8AS2 allows easy monitoring of the voltages, currents, and maximum currents of each system and all systems.

Previous

To monitor the facility conditions, the power supply current and voltage are checked with a tester and recorded before work and before and after maintenance.

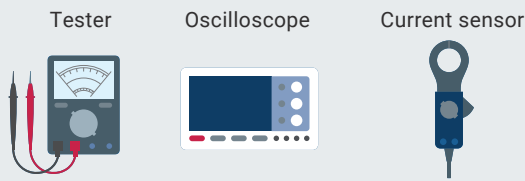

S8AS2

The voltage and current can be easily checked on the display of the S8AS2, without using a tester.

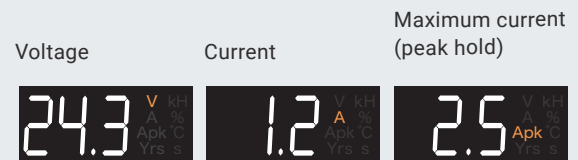

Predictable replacement timing, eliminating the need for regular inspections

By visualizing the service life, the product can be used more efficiently, minimizing waste and reducing the workload associated with regular inspections and replacements.

Previous

The power supply output voltage is regularly measured with a tester.

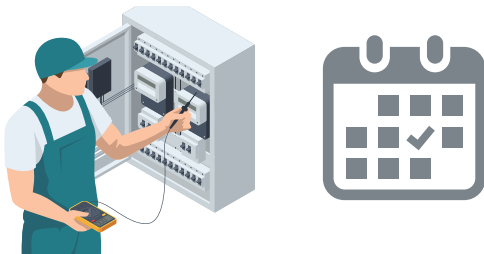

S8AS2

The display of the S8AS2 shows the replacement time for you to check without a tester.



- Workload increases as the systems and circuits increase.
- Inspection is necessary every six months.

- Simply press the button even if systems and circuits increase.
- Check when the replacement time approaches.

Simplified selection and stabilization of power circuits

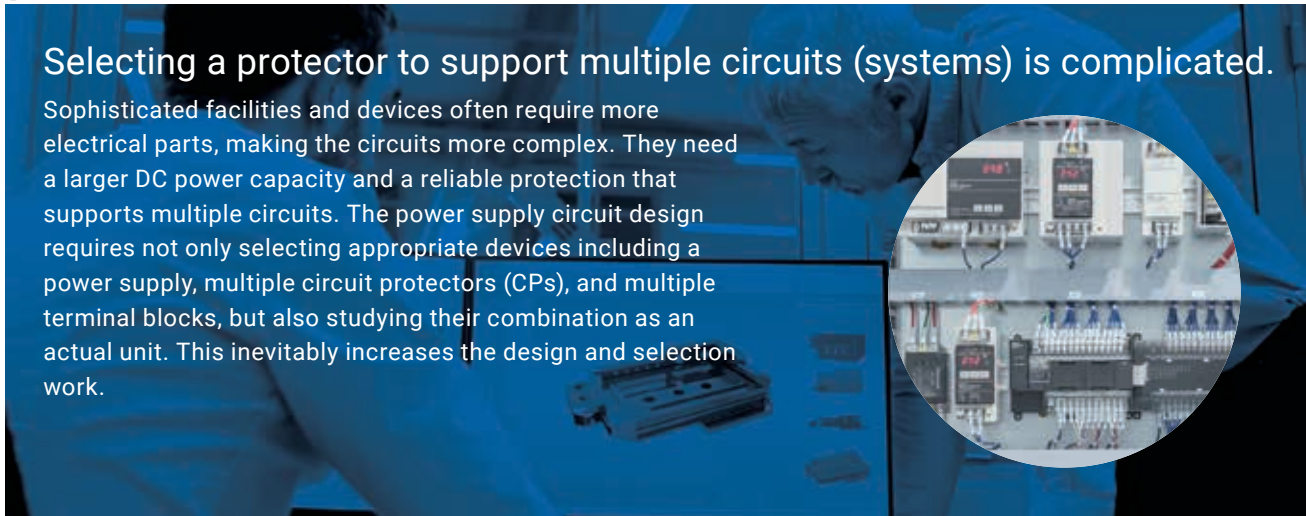

Selecting a protector to support multiple circuits (systems) is complicated.

Sophisticated facilities and devices often require more electrical parts, making the circuits more complex. They need a larger DC power capacity and a reliable protection that supports multiple circuits. The power supply circuit design requires not only selecting appropriate devices including a power supply, multiple circuit protectors (CPs), and multiple terminal blocks, but also studying their combination as an actual unit. This inevitably increases the design and selection work.

Selecting power supply circuits

Consolidating power supply circuits for simplified device selection

A Power Supply, electronic CPs, and terminal blocks have been integrated into one unit, eliminating the need to prepare multiple devices and evaluate their combination.

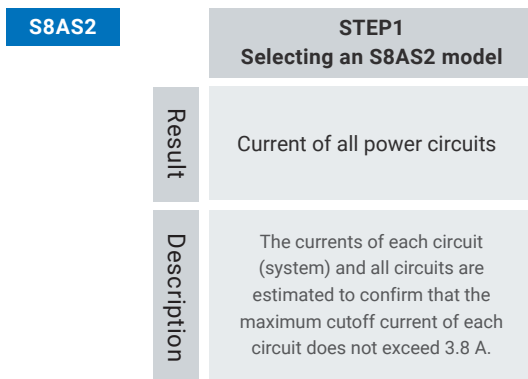
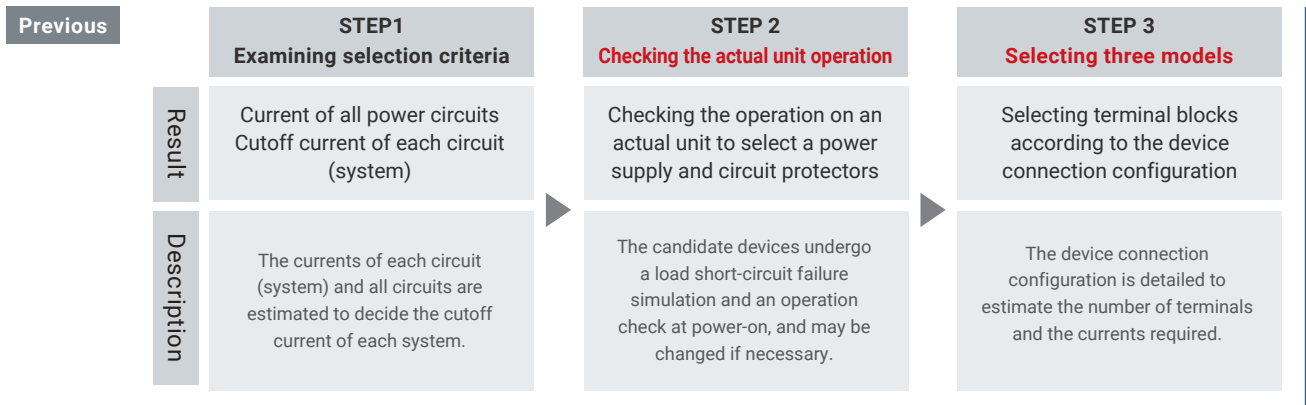

STEP 2 / STEP 3

Selection is completed in STEP 1 only.
(The same as when selecting a power supply only)

Stabilized power circuits by electronic circuit protectors with excellent cutoff performance

Electronic circuit protectors with excellent tripping performance can stabilize circuits at power-on or in case of a device error.

Standard electronic CP Careful examination is necessary to decide an appropriate combination based on the power supply and load characteristics. Otherwise, a slight delay may occur in the cutoff operation and cause a voltage drop in other systems, potentially resulting in operational failure.

S8AS2's electronic CP The electronic CP integrated into S8AS2 can ideally control the cutoff operation using our proprietary technology that enables it to adapt to the power supply characteristics. It can provide a reliable cutoff for a wide range of load characteristics.

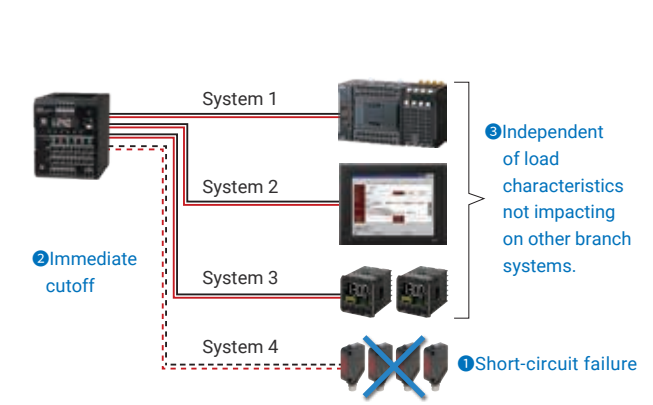
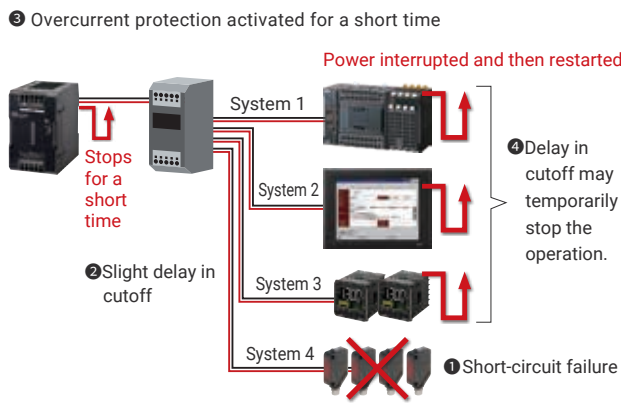

Why an electronic circuit protector?

Mechanical CP A mechanical CP has a fixed tripping current specific to the model. It shows large variations in tripping performance between units, making it difficult to select an appropriate CP.

Electronic CP An electronic CP has a variable tripping current with high tripping accuracy, allowing you to select, evaluate, and inspect the CP in a shorter time.

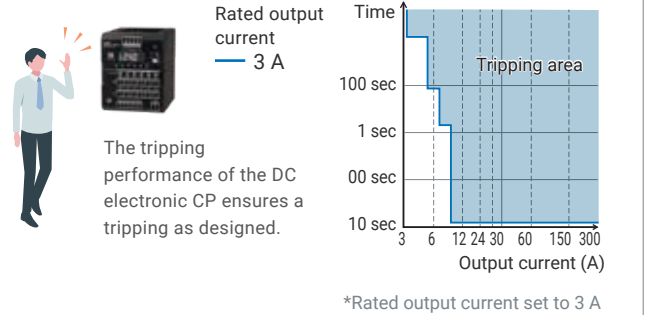
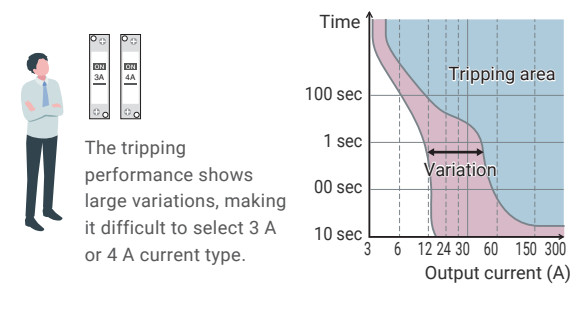

Mechanical CP In case of an error, the power supply's protection is activated before the mechanical CP's cutoff, causing all systems to stop.

Electronic CP The error system is identified and immediately cut off, allowing recovery in a shorter time.

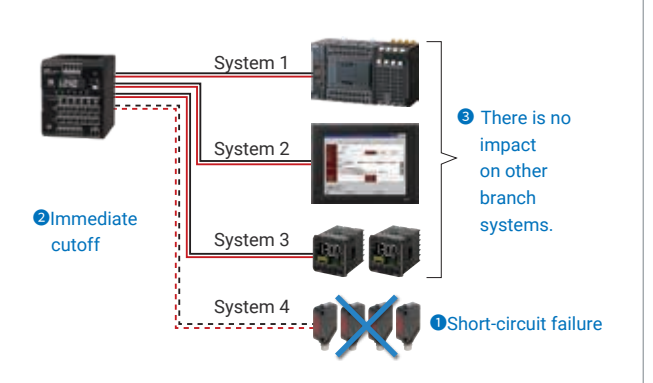
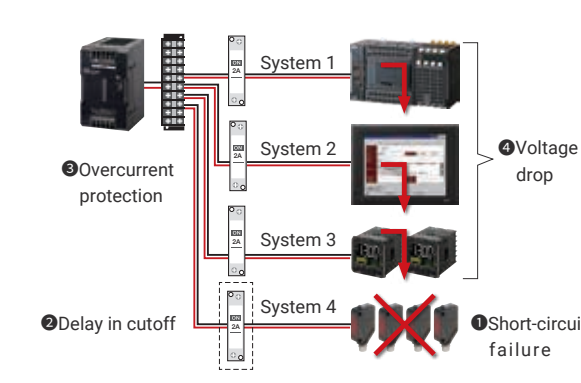

Reducing GHG emissions of control panels

Power Issues in control panel

Many devices in control panel consume their own energy, which is then lost as heat. Among them, DC power supplies are one of the most powerful devices.

*1. Percentage of power consumption based on the conceptual control panel designed by OMRON, according to OMRON investigation in May 2023.

Power Consumption in Control Panel

Component	Percentage
DC Power supply	39% ^{*1}
Transformer	-
SSR	-

Effect in reducing power loss through the selection of highly efficient Power Supply

CO₂ is one of the greenhouse gas (GHG). Using a more efficient DC Power Supply reduces the power consumed within control panel and consequently reduces CO₂ emissions.

<p>Previous</p> <p>OMRON'S 240 W model</p>  <p>87% typ /230 VAC</p>	<p>CO₂ emission volume 93 kg^{*2} reduced</p>	<p>Efficiency 8% improvement (87%→95%)</p>	<p>S8AS2</p> <p>S8AS2 240 W</p>  <div style="border: 1px solid blue; border-radius: 50%; padding: 10px; display: inline-block; text-align: center;"> <p>Power consumption approx. 65% reduction</p> </div> <p>95% typ /230 VAC (power supply section only: 96% typ /230 VAC)</p>
<p>Our conventional Power Supply S8AS 480 W</p>  <p>88% typ /230 VAC</p>	<p>CO₂ emission volume 162 kg^{*3} reduced</p>	<p>Efficiency 7% improvement (88%→95%)</p>	<p>S8AS2 480 W</p>  <div style="border: 1px solid blue; border-radius: 50%; padding: 10px; display: inline-block; text-align: center;"> <p>Power consumption approx. 61% reduction</p> </div> <p>95% typ /230 VAC (power supply section only: 96% typ /230 VAC)</p>

*2. Estimated on 8h/day x 365 days, 240 W output power, 1 Wh=0.4591 g (the in-house conversion rate from electricity to CO₂ emission).

*3. Estimated on 8h/day x 365 days, 480 W output power, 1 Wh=0.4591 g (the in-house conversion rate from electricity to CO₂ emission).

For building green control panels

Natural disasters caused by global warming and climate change have become global social issue, that drives over 150 countries and regions worldwide to take action toward decarbonization. Our goal is to reduce greenhouse gas (GHG) emissions toward by half through new ways of building control panels, that key figure of the manufacturing site.



Green

Creating green control panels

Reducing GHG emission of control panels to achieve carbon neutrality

This Value Design also integrate environment consideration concept that enable earth and user-friendly control panel building.

Process

Innovation for design, building Process

Realize greatly reduces design/manufacturing work

eCAD library provided for all models greatly reduces design work. Push-In Plus technology requires only a single step, greatly reducing wiring work.

Panel

Further Evolution for Panels

Realize compact & highly reliable control panels

Unified size and side-by-side mounting help delivering more compact control panels with additional functionality. OMRON Push-In Plus technology for easy wire insertion and firm wire holding ability.

People

Simple & Easy People

Provide reliable and comfortable manufacturing for all people who deal with control panels

OMRON's Push-In Plus technology is as easy as inserting to an earphone jack. This reduces the load on worker fingers.



Integrating green perspectives into Value Design

Value Design for Panel (Value Design) is the common concept shared across OMRON's in-panel product specifications to deliver new value to your control panels. This Value Design also integrate environment consideration concept that enable earth and user-friendly control panel building.

Smart Power Supply (240/480 W) S8AS2

Inheriting tripping performance with the renewal, while renewing Efficiency, size, and design.



- Power supply, protection, and connection three functions integrated into one package (compact/reduce wiring work)
- Stabilizes the power supply circuit with excellent tripping characteristics
- Equipped with multiple electronic circuit protectors and a wealth of connection terminals
- Compliant with UL Class 2 Outputs, enhancing UL conformity for connected devices and wire
- No measurement required, with digital display enabling grasp of the power supply circuit's status (Output voltage, Output current, replacement timing notification, Temperature, etc.)
- Circuit protectors ON/OFF control possible with front key operation



For the most recent information on models that have been certified for safety standards, refer to your OMRON website.

Please refer to *Power Supply Common Precautions and Please Use Correctly* on page 34.

Model Number Structure

Model Number Legend

S8AS2-□□□□□-□□□□□
 Series 1 2 3 4 5

- | | | |
|---|---|--|
| <p>1. Capacity
 240: 240 W
 480: 480 W</p> | <p>2. Output voltage
 24: 24 V</p> | <p>3. Number of Outputs Branches (Number of Channels)
 06: 6
 08: 8</p> |
| <p>4. Class 2 compatible
 S: Class 2 compatible</p> | <p>5. Parameter settings
 Blank: Changeable
 N: Not changeable</p> | |

Ordering Information

Main unit

Capacity	Input voltage	Output voltage	Maximum Output current (Per output branch)	Total output current	Number of output branches	Parameter settings	Model
240 W	100 to 240 VAC	24 V	3.8 A	10 A	6	Changeable	S8AS2-24024-06S
Not Changeable						S8AS2-24024-06SN	
480 W				20 A	8	Changeable	S8AS2-48024-08S
						Not Changeable	S8AS2-48024-08SN

Be sure to read and fully understand the content of the S8AS2 User's Manual (Man. No. T242) before changing settings on the S8AS2.

S8AS2

Specifications

S8AS2-24024-06□

Model		S8AS2-24024-06S	S8AS2-24024-06SN	
Efficiency	100 VAC input *1	93% typ. (Power supply section only: 94% typ.)		
	230 VAC input *1	95% typ. (Power supply section only: 96% typ.)		
Input conditions	Input voltage allowable range *3	85 to 264 VAC		
	Frequency *3	50/60 Hz (47 to 63 Hz)		
	Input current	2.6 A typ. (100 VAC input)		
		1.3 A typ. (200 VAC input)		
	Power factor	0.9 or greater		
	Leakage current	0.5 mA max. (100 VAC input)		
		1 mA max. (200 VAC input)		
Inrush current (for a cold start at 25°C)	14 A typ. (100 VAC input)			
	28 A typ. (200 VAC input)			
Output characteristics	Number of branches	6		
	Maximum cutoff output current (per branch)	3.8 A		
	Total output current	10 A		
	Voltage variable range *4	24 to 28 V (adjustable with V.ADJ)		
	Ripple noise voltage (at rated input and outputs) *1	80 mV max. at 20 MHz of bandwidth		
	Output leakage current	10 mA max.		
	Input fluctuation	0.5% or less (at input 85 to 264 VAC, 100% Load) *2		
	Load fluctuation	4.0% or less (at rated input, 0 to 100% Load) *2		
	Ambient temperature fluctuation	0.05%/°C max.		
	Startup time *5	600 ms typ. *1		
	Outputs hold time *5	30 ms typ. (at rated input and outputs) *1		
	Functions	Tripping functions	Abnormal voltage tripping	26.0 to 32.0 V
Abnormal current tripping *5			Setting range: 0.5 to 3.8 A (in 0.1 A Unit)	3.8 A (fixed)
Abnormal current tripping type			Standard (default)	Extended time (Cannot be changed.)
Abnormal total current tripping			If a total output current equivalent to 17 A for 2 s min., 15 A for 5 s min., 13 A for 10 s min., or 12 A for 20 s min. flows, it will be interrupted.	
Tripping Alarm Output			MOSFET relay output 30 VDC or less, 50 mA or less, leakage current 0.1 mA or less, residual voltage 2 V or less	
Undervoltage detection functions		Undervoltage alarm	Setting range: 18.0 to 26.4 V (in 0.1 V Unit)	20.0 V (fixed)
		Undervoltage Detection Output	MOSFET relay output 30 VDC or less, 50mA or less, leakage current 0.1 mA or less, residual voltage 2 V or less	
Maintenance Forecast Monitor Function		Years up to replacement time	Setting range: 0.0 to 5.0 yr (in 0.1 yr Unit)	0.5 yr (Cannot be changed.)
		Percentage up to replacement time	Setting range: 0.0 to 99.9% (in 0.1% Unit)	0% (Cannot be changed.)
		Total running time	Setting range: 0 to 132 kWh (in 1 kWh Unit)	132 kWh (fixed)
		Maintenance Forecast Monitor Output	MOS FET relay output 30 VDC or less, 50 mA or less, leakage current 0.1 mA or less, residual voltage 2 V or less	
Over-temperature detection function		Over-temperature	Setting range: 25 to 100°C (1°C unit)	100°C (fixed)
		Over-temperature output	MOSFET relay output 30 VDC or less, 50 mA or less, leakage current 0.1 mA or less, residual voltage 2 V or less	
Display functions		Output voltage display	Display range: 16.3 to 32.0 V Display accuracy: 2% rdg ±1 digit max.	
		Output current display	Branch output current Display range: 0.0 to 20.0 A Branch output peak current display range: 0.0 to 20.0 A Total output current display range: 0.0 to 60.0 A Display accuracy: 5% FS (4 A) ±1 digit max.	
		Maintenance forecast monitor display (yr)	Display range: FUL (Full) /HLF (Half) /Replacement period from 0.0 to 4.9 years	
		Maintenance forecast monitor display (percentage)	Display range: 0.0 to 99.9%	
		Total running time	Display range: 0 to 132 kWh	
		Temperature display	Display range: -20 to 120°C Display accuracy: 2°C ±1 digit max.	

Model		S8AS2-24024-06S	S8AS2-24024-06SN
Additional features	External Tripping Input	The input can be enabled or disabled for each branch output. 19.2 to 30.0 VDC, minimum signal width: 10 ms, tripping after input within 20 ms + the shutdown sequence set time	All branch outputs: Enabled (Cannot be changed.) 19.2 to 30.0 VDC, minimum signal width 10 ms or more, 20 ms after input
	Startup sequence	Setting range: 0.0 to 99.9 seconds (0.1-second Unit)	Branch output 1: 0.0 s (fixed) Branch output 2: 0.4 s (fixed) Branch output 3: 0.8 s (fixed) Branch output 4: 1.2 s (fixed) Branch output 5: 1.6 s (fixed) Branch output 6: 2.0 s (fixed)
	Shutdown sequence	Setting range: 0.0 to 99.9 seconds (0.1-second Unit)	All branch outputs: 0.0 s (Cannot be changed.)
	Series connection	Not supported.	
	Parallel connection	Not supported.	
	Output indicator	Provided (Color: green)	
	Indication monitor	Measurement/displayed details	For details, refer to <i>S8AS2 Users Manual</i> (Man. No. T242).
Main display area		Seven-segment display (Color: white)	
Channel display area		Seven-segment display (Color: green)	
Unit display area		Provided (Color: yellow)	
Withstand voltage	Dielectric strength voltage	3 kVAC for 1 min between all input terminals collectively and all branch output terminals, all I/O signal terminals collectively (Detection current: 20 mA)	
		2 kVAC for 1 min between all input terminals collectively and protective earth (Detection current: 20 mA)	
		1 kVAC for 1 min between protective earth and all branch output terminals, all I/O signal terminals collectively (Detection current: 30 mA)	
		500 VAC for 1 min between all branch output terminals and all I/O signal terminals collectively (Detection current: 20 mA)	
		500 VAC for 1 min between all output signals and all input signals collectively (Detection current: 20 mA)	
Insulation resistance	100 MΩ min. at 500 VDC between the protective earth terminal or all input terminals collectively and all branch output terminals, and all I/O signal terminals collectively		
Environment	Ambient operating temperature	-25 to 70°C (with no condensation or icing) *5	
	Storage temperature	-40 to 85°C	
	Ambient operating humidity	95% max.	
	Storage humidity	95% max.	
	Vibration resistance	10 to 55 Hz, 0.375 mm single amplitude, 3 directions, 2 h each	
	Shock resistance	150 m/s ² 3 times each in ±X, ±Y, ±Z directions.	
Reliability	MTBF	36,000 hours min.	
	Expected life	10 years	
Construction	Weight (main unit)	1,050 g max.	
	Cooling fan	blank	
	Protective structure	IP20 (Conforms to EN/IEC60529)	
Compatible standards	Harmonic suppression	Conforms to EN61000-3-2	
	EMI	Conducted EMI	Compliant with EN 61204-3 Class B, EN 55011 Class B
		Radiated EMI	Compliant with EN 61204-3 Class B, EN 55011 Class B *6
	EMS	EN 61204-3 high severity levels	
	Safety standards *7	UL 508 (Listing, Class 2 Output: Per UL 1310) CSA C22.2 No.107.1 (cUL, Class 2 Output: per CSA C22.2 No.223) EN/IEC 62477-1 (SELV/ES1 Output), OVCIII (I≤2,000 m), OVCII (2,000 m< and ≤3,000 m), Pol2 Conforms to PELV (EN/IEC60204-1) Conforms to EN/IEC61558-2-16 RCM (EN61000-6-4)	
SEMI standards	Compliance with SEMI F47-0706 (for 200 to 240 VAC input)		

Note: Refer to page 18 for *1 to *7.

S8AS2-48024-08□

Model		S8AS2-48024-08S	S8AS2-48024-08SN	
Efficiency	100 VAC input *1	93% typ. (Power supply section only: 94% typ.)		
	230 VAC input *1	95% typ. (Power supply section only: 96% typ.)		
Input conditions	Input voltage allowable range *3	85 to 264 VAC		
	Frequency *3	50/60 Hz (47 to 63 Hz)		
	Input current	5.2 A typ. (100 VAC input) 2.6 A typ. (200 VAC input)		
	Power factor	0.9 min.		
	Leakage current	0.5 mA max. (100 VAC input) 1 mA max. (200 VAC input)		
	Inrush current (for a cold start at 25°C)	14 A typ. (100 VAC input) 28 A typ. (200 VAC input)		
Output characteristics	Number of branches	8		
	Maximum interrupting Output current (per branch)	3.8 A		
	Total output current	20 A		
	Voltage variable range *4	24 to 28 V (by V.ADJ)		
	Ripple noise voltage (at rated Inputs and Outputs) *1	190 mV or less at 20 MHz of bandwidth		
	Output leakage current	10 mA max.		
	Static input fluctuation	0.5% or less (at input 85 to 264 VAC, 100% Load) *2		
	Load fluctuation	4.0% or less (at rated input, 0 to 100% Load) *2		
	Ambient temperature fluctuation	0.05%/°C max.		
	Startup time *5	600 ms typ. *1		
	Outputs hold time *5	30 ms typ. (at rated Inputs and Outputs) *1		
Functions	Tripping functions	Abnormal voltage tripping	26.0 to 32.0 V	32.0 V (fixed)
		Abnormal current tripping *5	Setting range: 0.5 to 3.8 A (in 0.1 A Unit)	3.8 A (fixed)
		Abnormal current tripping type	Standard (default)	Extended time (Cannot be changed.)
		Abnormal total current tripping	The total output current equivalent to 27 A for 1 s min., 25 A for 2 s min., and 22.5 A for 5 s min. will cause disconnection.	
		Tripping Alarm Output	MOSFET relay output 30 VDC or less, 50 mA or less, leakage current 0.1 mA or less, residual voltage 2 V or less	
	Undervoltage detection functions	Undervoltage alarm	Setting range: 18.0 to 26.4 V (in 0.1 V Unit)	20.0 V (fixed)
		Undervoltage Detection Output	MOSFET relay output 30 VDC or less, 50 mA or less, leakage current 0.1 mA or less, residual voltage 2 V or less	
	Maintenance Forecast Monitor Function	Years up to replacement time	Setting range: 0.0 to 5.0 yr (in 0.1 yr Unit)	0.5 yr (Cannot be changed.)
		Percentage up to replacement time	Setting range: 0.0 to 99.9% (in 0.1% Unit)	0% (Cannot be changed.)
		Total running time	Setting range: 0 to 132 kHz (in 1 kHz Unit)	132 kHz (fixed)
		Maintenance Forecast Monitor Output	MOSFET relay output Outputs of 30 VDC or less, 50 mA or less, leakage current of 0.1 mA or less, and residual voltage of 2 V or less	
	Over-temperature detection function	Over-temperature	Setting range: 25 to 100°C (in 1°C units)	100°C (fixed)
		Over-temperature output	MOSFET relay output Outputs of 30 VDC or less, 50 mA or less, leakage current of 0.1 mA or less, and residual voltage of 2 V or less	
	Display functions	Output voltage display	Display range: 16.3 to 32.0 V Display accuracy: 2% rdg ±1 digit max.	
		Output current display	Branch output current display range: 0.0 to 20.0 A Branch output peak current display range: 0.0 to 20.0 A Total output current display range: 0.0 to 60.0 A Display accuracy: 5% FS (4 A) ±1 digit max.	
		Maintenance forecast monitor display (yr)	Display range: FUL (Full) /HLF (Half) /0.0 to 4.9 years	
		Maintenance forecast monitor display (percentage)	Display range: 0.0 to 99.9%	
		Total running time	Display range: 0 to 132 kHz	
		Temperature display	Display range: -20 to 120°C Display accuracy: 2°C ±1 digit max.	

Model		S8AS2-48024-08S	S8AS2-48024-08SN	
Additional features	External Tripping Input	The input can be enabled or disabled for each branch output. 19.2 to 30.0 VDC, minimum signal width: 10 ms, tripping after input within 20 ms + the shutdown sequence set time	All branch outputs: Enabled (Cannot be changed.) 19.2 to 30.0 VDC, Minimum signal width: 10 ms, 20 ms after input	
	Startup sequence	Setting range: 0.0 to 99.9 seconds (in 0.1 second Unit)	Branch output 1: 0.0 s (fixed) Branch output 2: 0.4 s (fixed) Branch output 3: 0.8 s (fixed) Branch output 4: 1.2 s (fixed) Branch output 5: 1.6 s (fixed) Branch output 6: 2.0 s (fixed) Branch output 7: 2.4 s (fixed) Branch output 8: 2.8 s (fixed)	
	Shutdown sequence	Setting range: 0.0 to 99.9s (in 0.1s Unit)	All branch outputs: 0.0 s (Cannot be changed.)	
	Series connection	Not supported.		
	Parallel connection	Not supported.		
	Output indicator	Provided (Color: green)		
	Indication monitor	Measurement/displayed details	For details, refer to <i>S8AS2 Users Manual</i> (Man. No. T242).	
Main display area		Seven-segment display (Color: white)		
Channel display area		Seven-segment display (Color: green)		
Unit display area		Provided (Color: yellow)		
Withstand voltage	Dielectric strength voltage	3 kVAC for 1 min between all input terminals collectively and all branch output terminals, all I/O signal terminals collectively (Detection current: 20 mA)		
		2 kVAC for 1 min between all input terminals collectively and protective earth (Detection current: 20 mA)		
		1 kVAC for 1 min between protective earth and all branch output terminals, all I/O signal terminals collectively (Detection current: 30 mA)		
		500 VAC for 1 min between all branch output terminals and all I/O signal terminals collectively (Detection current: 20 mA)		
		500 VAC for 1 min between all input signal collectively and all output signal collectively (Detection current: 20 mA)		
Insulation resistance	100 MΩ min. at 500 VDC between the protective earth terminal or all input terminals collectively and all branch output terminals, and all I/O signal terminals collectively			
Environment	Ambient operating temperature	-25 to 70°C (with no condensation or icing) *5		
	Storage temperature	-40 to 85°C		
	Ambient operating humidity	95% max.		
	Storage humidity	95% max.		
	Vibration resistance	10 to 55 Hz, 0.375 mm single amplitude, 3 directions, 2 h each		
	Shock resistance	150 m/s ² 3 times each in ±X, ±Y, ±Z directions.		
Reliability	MTBF	36,000 hours min.		
	Expected life	10 years		
Construction	Weight (main unit)	Less than 1,400 g		
	Cooling fan	blank		
	Protective structure	IP20 (Conforms to EN/IEC60529)		
Compatible standards	Harmonic suppression	Conforms to EN61000-3-2		
	EMI	Conducted EMI	Compliant with EN 61204-3 Class B, EN 55011 Class B	
		Radiated EMI	Compliant with EN 61204-3 Class B, EN 55011 Class B *6	
	EMS	EN 61204-3 high severity levels		
	Safety standards *7	UL 508 (Listing, Class 2 Output: Per UL 1310) CSA C22.2 No.107.1 (cUL, Class 2 Output: per CSA C22.2 No.223) EN/IEC 62477-1 (SELV/ES1 Output), OVCIII (I≤2,000 m), OVCII (2,000 m< and ≤3,000 m), Pol2 Conforms to PELV (EN/IEC60204-1) Conforms to EN/IEC61558-2-16 RCM (EN61000-6-4)		
SEMI standards	Compliance with SEMI F47-0706 (for 200 to 240 VAC input)			

- *1. Rated input/output conditions: at rated input voltage, rated frequency, rated output voltage, and rated total output current.
- *2. 100% Load condition: at rated output voltage and rated total output current.
- *3. Do not use an inverter output for the Power Supply. Inverters with an output frequency of 50/60 Hz are available, but the rise in the internal temperature of the Power Supply may result in ignition or burning.
Do not connect a UPS with a square wave outputs to the input. There is a risk of smoke generation and burning due to the internal temperature rise of the product.
- *4. Voltage will increase above 28 V when adjusting the V.ADJ volume. When adjusting the Output voltage, please check the power supply output voltage to avoid damaging the Load. Also, when the Output voltage exceeds the Set value, all branch output will be shut off.
- *5. For details, please refer to *Inrush Current*, *Starting Time*, *Outputs Hold Time* on page 39.
- *6. EM (I Radiated EMI) complies with Class B status this product is installed inside a Control panel.
- *7. Please refer to *About Compatible standards* below.

About Compatible standards

- Regarding EN/IEC 61558-2-16
When acquiring EN/IEC 60204-1 (Machinery Safety), control circuits require a control transformer; however, products that have obtained safety standards with OVCIII or products adopting transformers compliant with EN/IEC 61558-2-16 may not require a control transformer.

Connection

Block Diagrams

S8AS2-24024-06

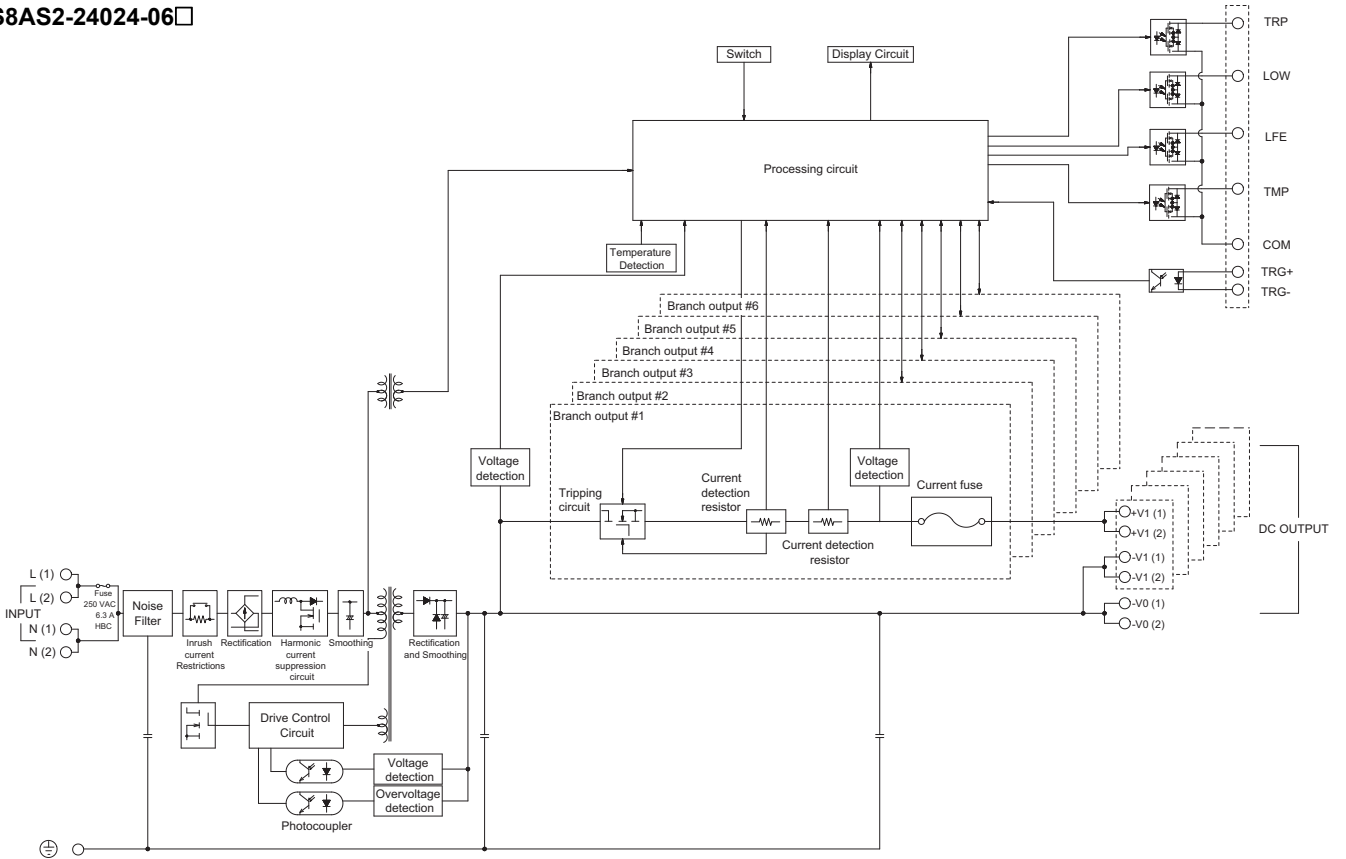

S8AS2-48024-08

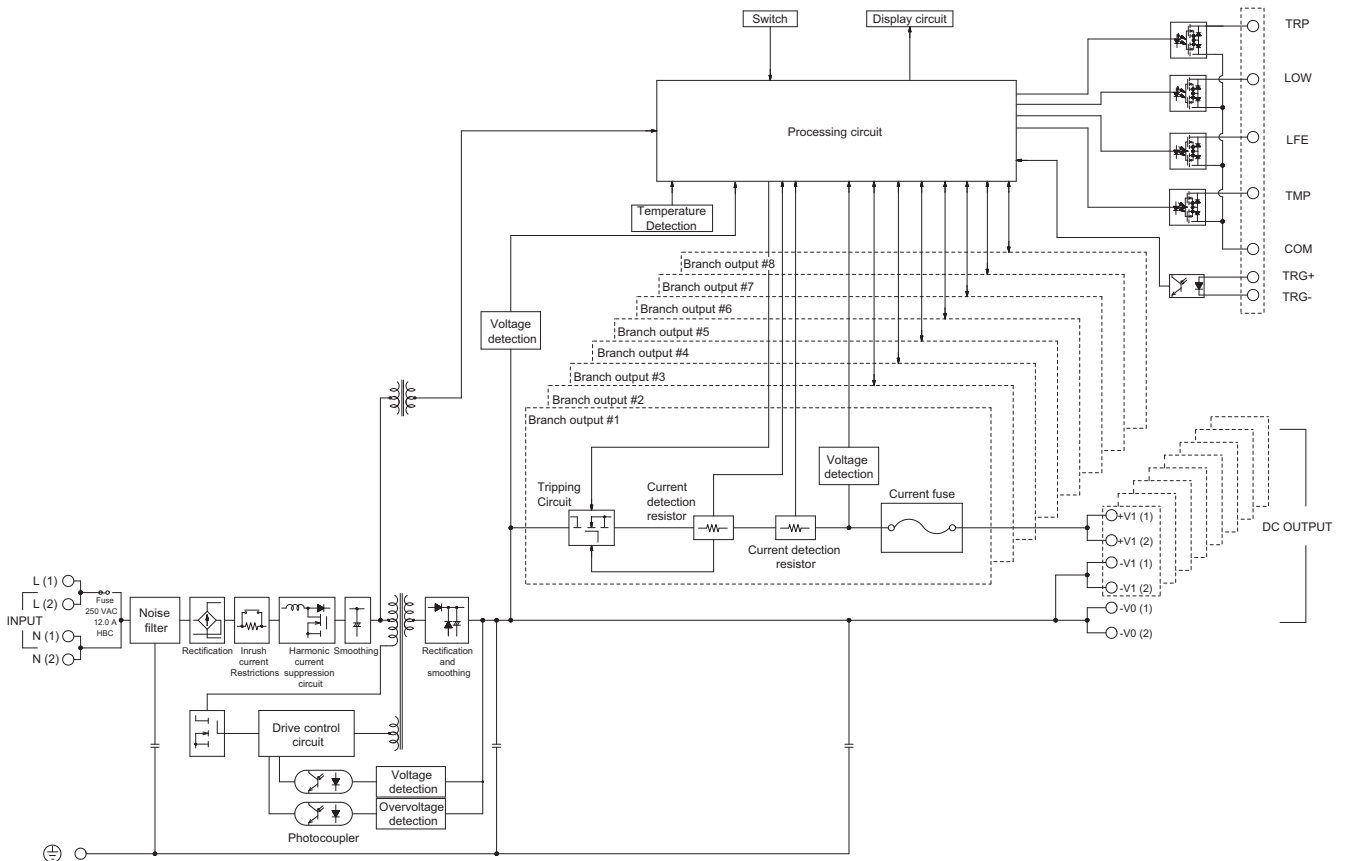

S8AS2

Constructions and Nomenclature

Nomenclature

S8AS2-24024-06□

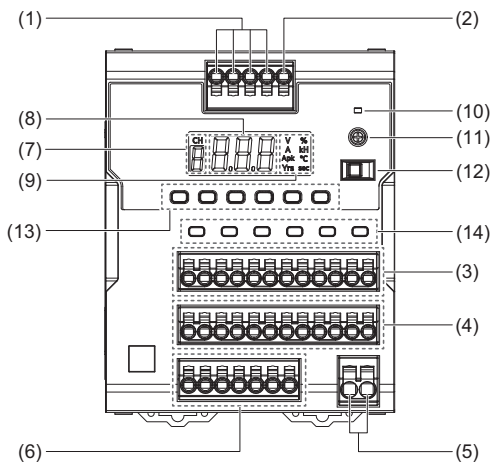

S8AS2-48024-08□

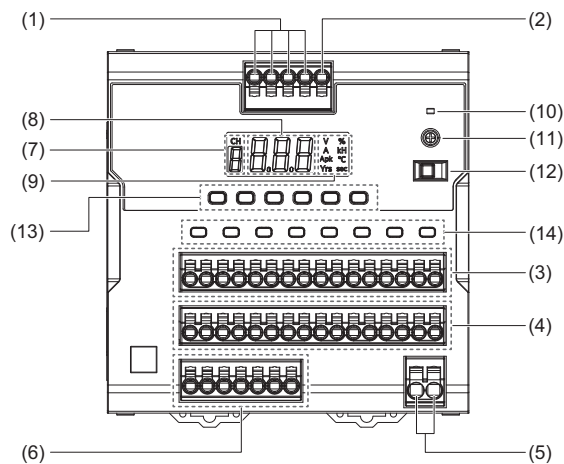

(4) Branch output terminal (-), (5) Common output terminals (-)
Internal circuit configuration

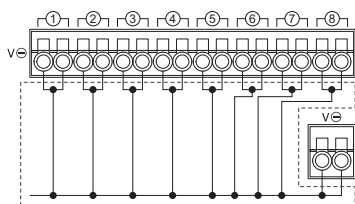

(6) I/O signal terminals
Internal circuit configuration

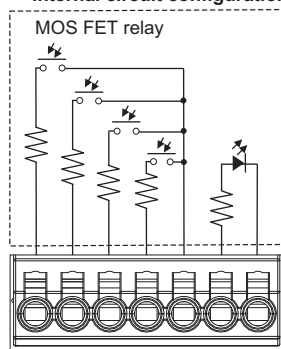

TRP LOW LFE TMP COM TRG(+) TRG(-)
(A) (B) (C) (D) (E) (F) (G)

No.	Name	Functions	
(1)	Input terminals (L), (N)	Connect the input power supply (100 to 240 VAC 50/60 Hz (commercial power supply)).	
(2)	PE (Protective Earth) Terminal \oplus	Connect the ground wire. *1	
(3)	Branch output terminal (+)	Push-in terminals with two-pole terminals per one Branch output.	
(4)	Branch output terminal (-)	Push-in terminal with two-pole terminals per one Branch output.	
(5)	Common output terminals (-)	Common push-in terminal for the (-) pole of each Branch output. For safety assurance, it is recommended to use this terminal when supporting PELV Outputs.	
(6)	I/O signal terminals	(A) Tripping Alarm Output (TRP)	Abnormal voltage and abnormal current are detected, and Outputs when a Tripping Operation occurs. (MOS FET Relay OFF)
		(B) Undervoltage Detection Output (LOW)	Outputs when the 24 VDC Output voltage falls below the threshold value due to factors such as a drop in input voltage. (MOSFET Relay OFF)
		(C) Maintenance Forecast Monitor Output (LFE)	Outputs when the remaining years of the set replacement period are reached. (MOS FET Relay OFF)
		(D) Over-temperature Output (TMP)	Outputs when the Temperature exceeds the threshold value. (MOS FET Relay OFF)
		(E) Common terminal (COM) (None polarity)	Common terminals for the above four Outputs
		(F) External Tripping Input + (TRG+)	It is possible to interrupt the branching circuit by an external input signal. *4
		(G) External Tripping Input - (TRG-)	
(7)	Branch output number LED (Green)	Displays the currently selected Branch output channel. *2	
(8)	7-segment LED (White)	Displays measured values or Set value.	
(9)	Unit indicator LED (Orange)	Lights up when the unit is related to the value displayed on the 7-segth LED (V, A, Apk, Yrs,%, kWh, °C, sec).	
(10)	Output indicator (DC ON (Green))	Indicates whether the Output voltage is being supplied or not.	
(11)	Output voltage adjuster (V.ADJ)	Adjusts the Output voltage.	
(12)	Mode switching SW	Switch between Monitor Mode and Setting Mode.	
(13)	Operation keys	Channel Down Key \checkmark	Indicates the switch for the Branch output.
		Channel Up Key \wedge	
		Selection Down Key ∇	Used to change the display item forward or to decrease a set value.
		Selection Up Key \blacktriangleright	Used to change the display item backward or to increase a set value.
		Enter Key —	Used to switch the display item, enter or execute settings, etc.
(14)	Channel selection key	Cancel (ESC)/Reset (RST) key ESC/RST	Switch the display Item, cancel, and when an abnormal Tripping Operation or alarm Outputs is operating, clear the abnormal Bit status.
			The indicator lights display the connection/disconnection Bit status of each Branch output. Tripping/Red, Connect/Green *3 The pushbutton switch switches the connection/disconnection of each Branch output.

*1. Since this is a PE (Protective Earth) terminal specified by Safety standards, please make sure to connect it to the ground.

*2. Except for current, the Branch output number LEDs will be Off.

*3. For details on how to display, refer to *Operation Display and Operation Methods of Channel selection key* on page 30.

*4. Wire the External Tripping Input with the correct positive/negative polarity. After wiring, confirm that it operates correctly.

Terminal Symbol

(1) Input terminal block (L), (N)/(2) PE (Protective Earth) terminal (⊕)

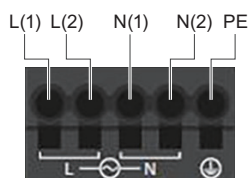

(3) Branch output terminal (+)/(4) Branch output terminal (-)/(5) Common output terminals (-)
 • 240 W Output terminals

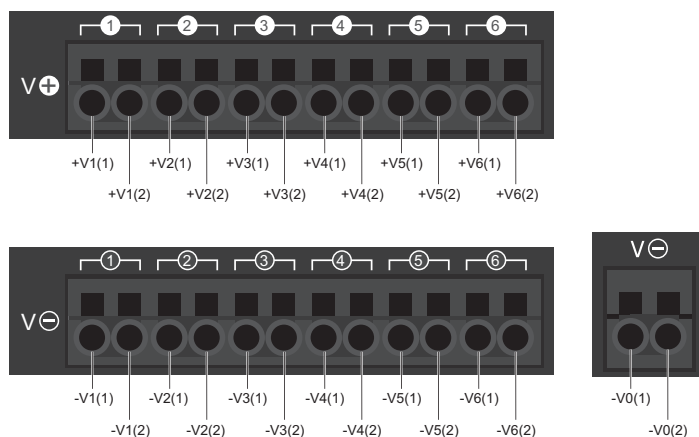

• 480 W Output terminals

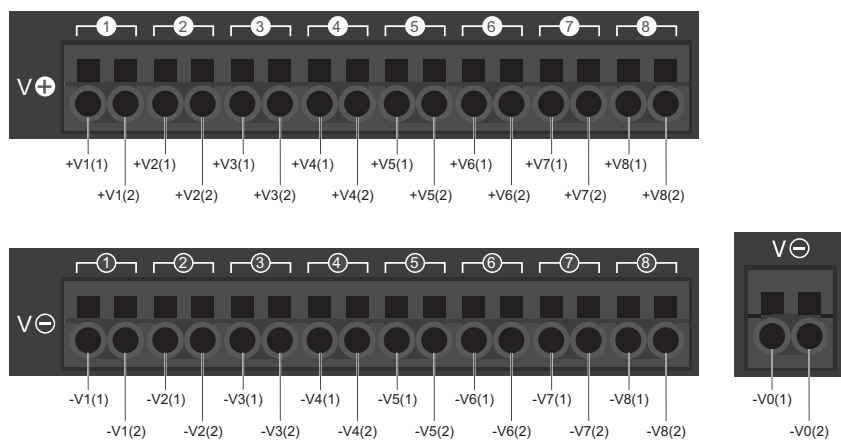

(6) I/O signal terminals

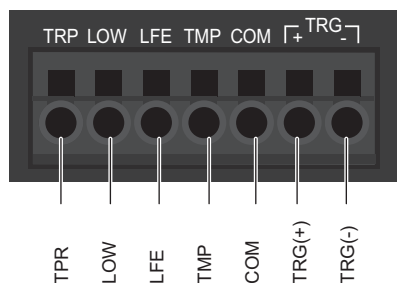

Characteristic Data

Derating curve

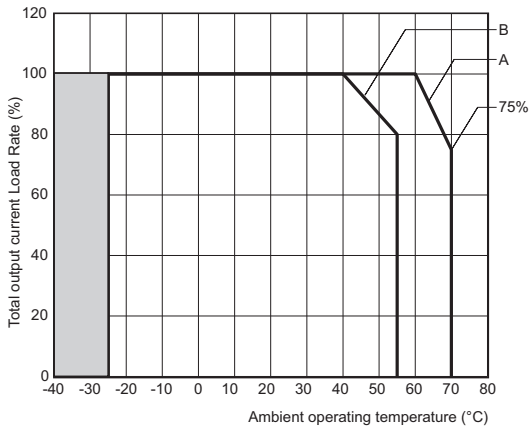

Note: 1. Within the range, it takes time from the application of input voltage until the rated Output voltage is produced. Also, the value of ripple noise may Yes outside the range described under "Ratings and Characteristics."

Note: 2. Please multiply the Load factor indicated by the above Outputs derating by the Load reduction coefficient relative to the input voltage and use the resulting value.

- A: At least 15 mm spacing between left and right during Standard installation
- B: Less than 15 mm spacing between left and right when mounted in Front contact

Load reduction factor for input voltage

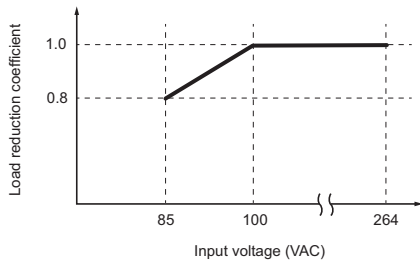

Abnormal Current Tripping Characteristics Functions

The current tripping characteristics can be selected from three types of Tripping type: Standard Detection, Instantaneous Detection, and Extended Detection. For details, please refer to the *Form S8AS2 Users Manual* (Man. No. T242).

- Note: 1.** In the event of an abnormal tripping, be sure to reset and restore the system only after the cause has been eliminated.
- Note: 2.** When using loads that operate with constant power, tripping may occur when the power is turned off.
- Note: 3.** The current tripping accuracy is within ± 0.3 A of the Set value.
- Note: 4.** For Extended Detection, please use this only when using our remote I/O terminal with short-circuit detection functions.

Current limiting by internal circuits

S8AS2 has a current Restrictions circuit inside to prevent a current exceeding a certain level from flowing. Until the tripping time is reached, the current is Restrictions by this characteristic.

Short-circuit Protection Fuse

If, due to some abnormality, the branch output cannot be tripping off by the tripping circuit, the short-circuit protection fuse will blow to protect the circuit.

Note: If the fuse blows, that branch output cannot be used.

Standard Detection

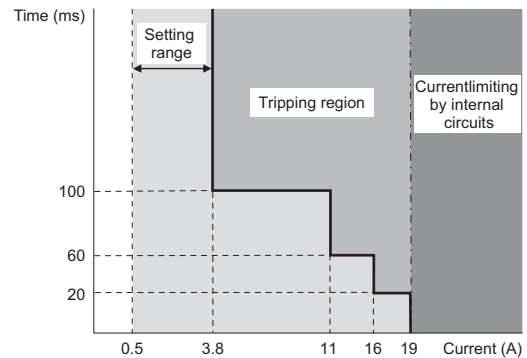

Instantaneous Detection

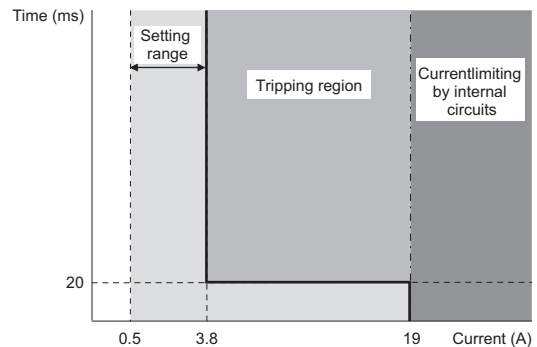

Extended Detection

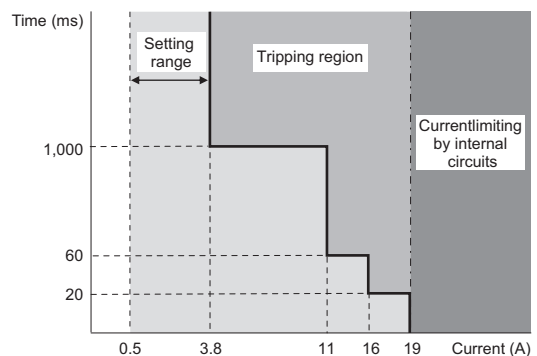

Functions

Tripping/Alarm Functions

Tripping Functions

Settings	Operating range	Parameters settings	Outputs cut off
Abnormal Voltage Tripping	Tripping when the output voltage exceeds the abnormal voltage tripping setting	Yes	All branch outputs
Short-circuit current tripping	Output cut off at 16 A for 20 ms max. Output cut off at 11 A for 60 ms max.	None	Individual branch output
Abnormal total current tripping	Tripping occurs when the sum of all branch output currents exceeds at a constant current value for a certain period of time.	None	All branch outputs
Abnormal current tripping *1	0.5 to 3.8 A (in 0.1-A increments) Select from standard, instantaneous, and extended detection methods.		Individual branch output
External tripping input	External input signal (TRG) ON		Specified output *2

*1. The tripping function operates within 100 ms when the S8AS2 is set to standard detection, within 20 ms when it is set to instantaneous detection, and within 1,000 ms when it is set to extended detection.

*2. Only Branch outputs that have their Tripping Operation via External Tripping Input set to Enabled are the Target.
(Refer to the *S8AS2 User's Manual* (Man. No. T242))

Alarm Output and Error Display Functions

Symbol	Output name	Operation	Error code displayed
TRP	Tripping Alarm Output	Abnormal Voltage Tripping Operation If the output voltage exceeds the abnormal voltage tripping setting, all branch outputs will be cut off and TRP output will turn ON. (The MOSFET relay output will turn OFF).	A10
		Abnormal Current Tripping Operation When the branch output current exceeds the set value, the branch output is cut off and the TRP output is turned ON. (The MOSFET relay output is turned OFF).	A11/Abnormal Current (Alternating)
		Volt-amperage (VA) Tripping Operation When the voltage times the current (VA) exceeds the set value for a specified amount of time, the branch output is cut off and the TRP output is turned ON (The MOSFET relay output is turned OFF).	A11/Abnormal Current (Alternating)
		Abnormal Total Current Tripping Operation When the total output current exceeds the set value, all branch outputs are cut off and the TRP output is turned ON (The MOSFET relay output is turned OFF).	A12
LOW	Undervoltage Detection Output	Setting range: 18.0 to 26.4 VDC (0.1-V increments) When the output voltage falls below the set value, the LOW output is turned ON (The MOSFET relay output is turned OFF).	A21/Abnormal Voltage Value (Alternating)
LFE	Maintenance Forecast Monitor Output	When the internally calculated replacement time falls below the set value, the LFE output is turned ON (The MOSFET relay output is turned OFF).	A23/Replacement time (alternating)
	Overheating alarm *1	LFE output is turned ON (the MOSFET relay output is turned OFF) when the replacement time cannot be calculated correctly due to rise in internal temperature.	A23/HOT (Alternating)
TMP	Over-temperature output	Setting range: 25 to 90°C (1°C increments) When the temperature falls below the set value minus 3°C, the TMP output and the error code shown on the seven-segment display will be automatically cleared.	A30/Temperature (Interactive)

*1. If the overheating alarm stays on for more than 3 hours, this alarm state can no longer be cleared.

Maintenance Forecast Monitor Function

This product has a built-in electrolytic capacitor. Electrolytic capacitors undergo degradation in characteristics, such as a decrease in capacitance, over time due to the evaporation of the internal electrolyte solution. This degradation begins at the time of manufacture as the impregnated electrolyte solution permeates the sealing rubber. Due to degradation of this electrolytic capacitor's characteristics, this product will become unable to perform sufficiently over time. The maintenance forecast monitor function calculates an estimated period until this product will no longer be able to perform sufficiently due to degradation of the electrolytic capacitor's characteristics. This feature can be used as a guideline for finding out when to replace the product main unit.

Note: The maintenance forecast monitor function indicates an estimated period until the product will no longer be able to perform sufficiently due to degradation of the electrolytic capacitor. This function does not cover failures caused by other factors.

Principle of Operation

The degradation rate of an electrolytic capacitor varies considerably with ambient temperature (generally following the doubling for every 10°C rule and the Arrhenius equation).

The S8AS2 monitors the internal temperature of the product while powered ON, and calculates the degradation level of the electrolytic capacitor based on running time and internal temperature.

Note: 1. Depending on the durability of the electronic components, we recommend replacing the electrolytic capacitors approximately 15 years after purchase, regardless of the maintenance forecast monitor number of years or percentage displayed.

Note: 2. The replacement time varies depending on changes in operating conditions. Check the display periodically.

Note: 3. In applications where the input power is frequently turned ON and OFF, the accuracy of the maintenance forecast monitor function may deteriorate.

Years up to replacement time

FUL is indicated at the time of purchase (when initially powered on), and continues to be indicated for approximately one month.

Afterward, the state of deterioration for the electrolytic capacitor is calculated based on the usage environment and **HLF** is indicated when deterioration progresses. When the years until replacement reaches 5 years or less, it is indicated in 0.1 step increments within the range of 4.9 to 0.0. (Depending on the usage environment, the number of years may be indicated after **FUL** without **HLF** being indicated.)

Note: The number of years until replacement may vary if there are frequent load variations or in locations where the ambient temperature fluctuates drastically.

Percentage up to replacement time

With the number of years until replacement at the time of manufacture set as 100%, as deterioration of the electrolytic capacitor progresses through use, it decreases in 0.1% step increments.

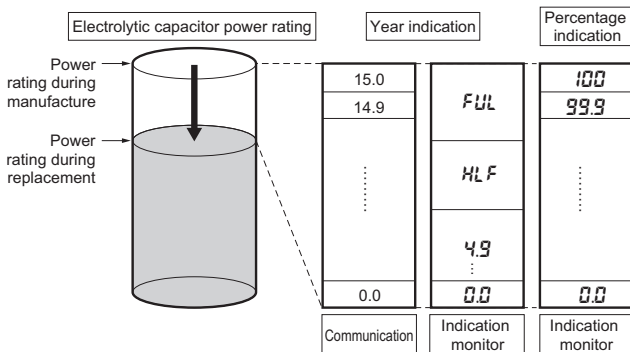

Relationship between electrolytic capacitor power rating and indicator

Total running time

The accumulated value of the product's time powered on is measured as the total run time.

The Total run time increases in 1 (kh) steps.

Time Chart

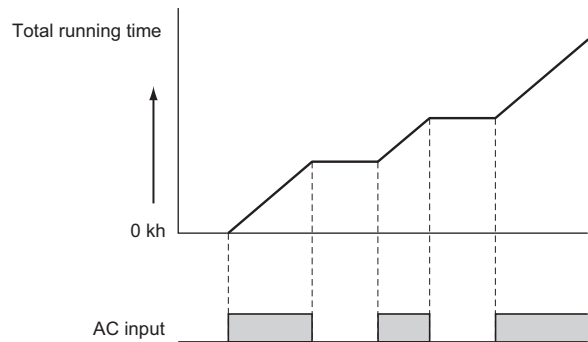

Note: 1. The total run time does not include the time that the Power Supply is OFF.

Note: 2. The total run time measures the total time that power is being supplied and is not related in any way to deterioration in the electrolytic capacitor built into the Power Supply or to the effects of the ambient temperature.

Maintenance Forecast Monitor Output (A23) Displayed

When error code A23 (maintenance forecast monitor output) is displayed on the seven-segment display, it indicates that the replacement time calculated by the S8AS2 has fallen below the set value. The number of years left before replacement is required will be displayed in half-year increments. Prepare to replace the Power Supply.

Startup Sequence Function

The inrush current may cause a voltage drop if all of the branch outputs are connected simultaneously and there is little spare capacity in the power supply or the loads connected to the branch outputs are capacitive loads. A significant voltage drop may cause an output to be cut off. In this case, a time delay can be applied between the connections of the branch outputs to minimize the voltage drop.

Note: 1. The time delay can be set between 0.0 and 99.9 s. (If the delay is set to 0.0 s, the startup sequence will not operate and the branch output will be connected immediately.)

Note: 2. The sequence Functions is only guaranteed between individual Branch output. When using multiple S8AS2 units, time synchronization between each S8AS2 unit cannot be maintained.

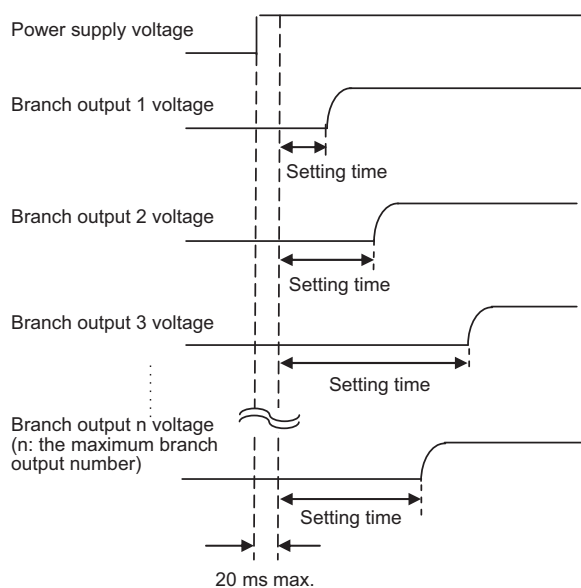

- The branch output's status indicator will flash green during the startup sequence time until it is connected.
- For details on verification of the startup sequence, refer to the *S8AS2 User's Manual* (Man. No. T242).
- The startup sequence for models with unchangeable settings (S8AS2-□□-□SN) cannot be changed.

Branch output number	1	2	3	4	5	6	7	8
Setting time	0.0 s	0.4 s	0.8 s	1.2 s	1.6 s	2.0 s	2.4 s	2.8 s

Shutdown Sequence Function

When the S8AS2's input power supply is turned OFF, all of the branch outputs are turned OFF (disconnected) simultaneously. On the other hand, when the branch outputs are cut off by the external tripping input or communications, a time delay can be applied between the branch output disconnections.

Note: 1. The time delay can be set between 0.0 and 99.9 s. (If the delay is set to 0.0 s, the startup sequence will not operate and the branch output will be cut off immediately.)

Note: 2. The sequence functions is only guaranteed between individual Branch output. When using multiple units of the S8AS2 model, time synchronization between each S8AS2 model cannot be achieved.

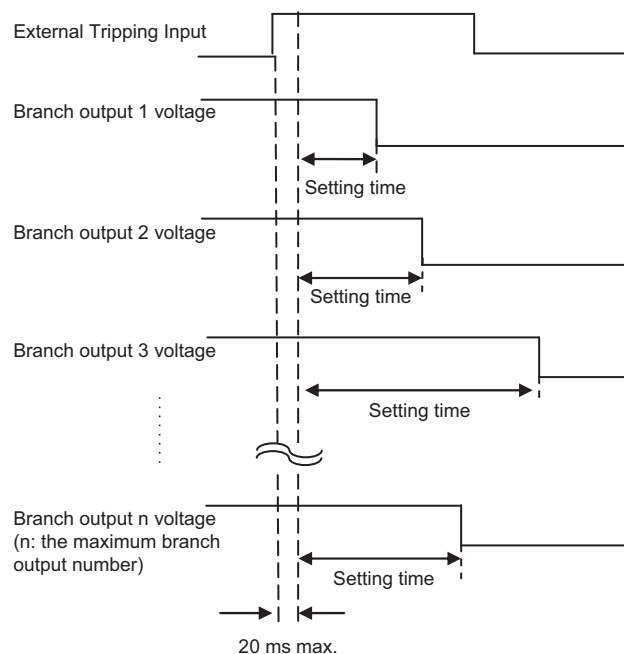

Note: 3. When operation is cut off due to an abnormal voltage, all of the branch outputs will be cut off simultaneously.

Note: 4. The shutdown sequence function will operate on a branch output only if the external tripping input is enabled for that branch output. For details, refer to the *S8AS2 User's Manual* (Man. No. T242).

Note: 5. The shutdown sequence setting times for all branch outputs for the S8AS2-□□-□SN are set to 0.0 s and cannot be changed.

- For details on verification of the shutdown sequence, refer to the *S8AS2 User's Manual* (Man. No. T242).

Monitor Functions

Parameter name (display order)	Details
Output voltage	Displays the output voltage.
Output current	Displays the current value of each branch output.
Total current	Displays the total current value of all the branch outputs.
Peak current	Displays individual branch output peak currents.
Years up to replacement time	Displays the remaining number of years up to the replacement time by forecasting the replacement time of the S8AS2.
Percentage up to replacement time	Displays the remaining number of percentage up to the replacement time by forecasting the replacement time of the S8AS2.
Total running time	Displays the running time of the S8AS2.
Temperature	Displays the internal temperature of the S8AS2.

For details, refer to *Operation in Monitor Mode* on page 27.

Setting Functions

Parameter name (display order)	Details
Abnormal current tripping threshold	The current tripping threshold can be set for each branch output in 0.1-A increments.
Abnormal current tripping type	The tripping type can be set for each branch output. USU: Standard (tripping within 100 ms) INS: Instantaneous (tripping 20 ms max.) LNG: Extended time (tripping within 1,000 ms)
Abnormal voltage tripping threshold	The abnormal voltage tripping threshold can be set for the output voltage.
Undervoltage detection threshold	The undervoltage detection output (LOW) is output when the output voltage of the S8AS2 falls below this detection threshold. The detection threshold can be set in 0.1-V increments. Branch outputs will not be cut off.
Maintenance forecast output threshold	Set the expected number of years until the S8AS2 needs to be replaced. When the estimated value falls below the set value, the maintenance forecast monitor output (LFE) will turn ON. (The MOSFET relay output will turn OFF.)
Maintenance forecast percentage threshold	Set the expected number of percentage until the S8AS2 needs to be replaced. When the estimated value falls below the set value, the maintenance forecast monitor output (LFE) will turn ON. (The MOSFET relay output will turn OFF.)
Running time alarm threshold	Sets the running time alarm threshold of the S8AS2. When the running time exceeds this threshold, the maintenance forecast monitor output (LFE) will activate.
Temperature alarm threshold	An excessive temperature rise inside the S8AS2 will be detected and the over-temperature output (TMP) will turn ON. (The MOSFET relay output will turn OFF.) This output can be used to control cooling equipment to reduce the temperature in the control panel.
Startup sequence	When connection of branch outputs is initiated when the power is turned ON, a time delay can be set for each individual branch output. Connecting the branch outputs in sequence instead of simultaneously can reduce the inrush current and reduce the load on the Power Supply.
Shutdown sequence	Branch outputs can be disconnected in sequence initiated by communications or an external tripping input (TRP), and a time delay can be set for the sequence.
Tripping trigger enable/disable	The external tripping input function (TRG) can be enabled (ON) or disabled (OFF) for each branch output.
Tripping trigger type	The tripping trigger type can be set for all branches that have the tripping input function enabled.
Software tripping trigger *1	This function allows a trigger input to be virtually entered by only key operation. This enables operation to be checked instead of external tripping input (TRG).
Startup operation check test *1	This function is for checking operation when the power is turned ON by only key operation. This is used to check operation when the power is started up (e.g. startup sequence) when it is difficult to turn the power supply ON and OFF.
Reset function setting	The tripping alarm output and alarm output can be cleared after removing the cause of the alarm by the following two methods. • KEY: RST Key only enabled • ALL: RST Key or turning power OFF and ON again.
Protection level *1	The Protection Level function can restrict parameter read/write access by setting one of three levels. The default protection level is level 1.
Channel selection key Enabled/Disabled *1	Although connection/disconnection can be switched by the channel selection key, this function can be set to disabled to prevent malfunction. The default is "Enabled".
Initialize defaults	This is used to return all settings to their default states.

*1. These parameters can be set even on the S8AS2-□□-□SN (model on which settings cannot be made).

For details, refer to *Operations in Setting Mode* on page 28.

The Monitor Mode and Setting Mode of the S8AS2

When the S8AS2 is turned ON for the first time, it will enter Monitor Mode with all of the branch outputs turned ON.

To set unused branch outputs to non-connected, configure this using the Channel switch key.

Additionally, in Setting Mode, various parameters can be modified.

Operation in Monitor Mode

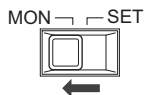

In Monitor mode, the output voltage, output current, total output current, peak current output, years until replacement, percentage until replacement, total run time, and internal temperature can be read.

(1) Output voltage



(1) Displays the output voltage value

(2) Output current

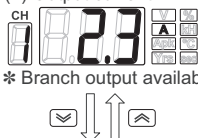

(2) Displays the Current of the Branch output. The branch output can be changed by pressing the Channel Down/UP Keys.

* Branch output available

(3) Total output current



(3) Displays the Total current value.

(4) Peak current Outputs

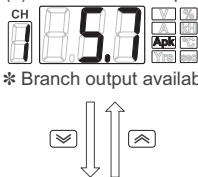

(4) Displays the peak current output of the branch output. The branch output can be changed by pressing the Channel-Down/UP Keys. The peak current output can be cleared using the following steps:

- 1) Press the Enter Key.
- 2) Switch from the NO display to either
 YES: Clear the selected branch output
 or
 ALL: Clear all outputs using the Select Down/UP Keys.
- 3) Press the Enter Key.

* Branch output available

(5) Years up to replacement time



(5) Displays the Years up to replacement time.

(6) Percentage up to replacement time

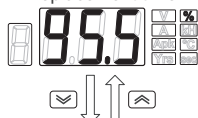

(6) Displays the Percentage up to replacement time.

(7) Total running time



(7) Displays the Total running time.

(8) Temperature



(8) Displays the internal Temperature.

(1) Transition to Output voltage display

* The displayed items and branch output are retained when leaving Monitor Mode. When moving back to Monitor Mode, the displayed items will be those that were retained, along with the branch output.

Operations in Setting Mode

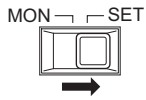

Changes to the settings of the S8AS2 are made in Setting Mode. However, due to operational restrictions of the Protection Level, there may be setting values that cannot be modified and are hidden. Change the protection levels needed. Refer to the User's Manual for details on parameters and restrictions for the Protection Level. In the S8AS2-□□-□SN, parameters (1) to (7) are not displayed and cannot be changed, regardless of the Protection Level.



(1) Abnormal current tripping threshold (C-V)

(1) Used to set the abnormal current tripping threshold for each branch output. The output will be shut off and the abnormal tripping output (TRP) will operate if the branch output current exceeds the value set here. Setting range: 0.5 to 3.8 A
* Press the Channel Down/UP Keys to switch to other branch outputs.

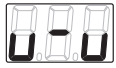
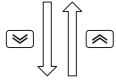

(2) Abnormal voltage tripping threshold (V-V)

(2) Set the abnormal voltage tripping threshold. The output will be shut off and the abnormal tripping output (TRP) will operate if the output voltage exceeds the value set here. Setting range: 28.0 to 32.0 V



(3) Undervoltage detection threshold (V-U)

(3) Set the undervoltage alarm threshold. The undervoltage detection output (LOW) will operate when the output voltage falls below the value set here. Setting range: 18.0 to 26.4 V



(4) Maintenance forecast output threshold (LFE)

(4) Set the maintenance forecast monitor output threshold. The replacement time for the S8AS is calculated from the operating time and internal temperature. The maintenance forecast monitor output (LFE) will operate when the replacement time falls below the value set here. Setting range: 0.0 to 5.0 years



(5) Maintenance forecast percentage threshold (LFP)

(5) Set the percentage threshold for the replacement period. If the calculated lifespan percentage, based on operating hours and internal temperature, falls below the threshold, the maintenance forecast monitor output (LFE) will be activated. Setting range: 0.0 to 99.9%



(6) Running time alarm threshold (TIM)

(6) Set the run time threshold. If the run time exceed the threshold, the maintenance forecast monitor output (LFE) will be activated. Setting range: 0 to 132 kh



(7) Temperature alarm threshold (TMP)

(7) Set the Temperature Alarm Threshold (TMP). If the internal temperature exceeds the threshold, the temperature output (TMP) will be activated. Setting range: 25 to 100°C

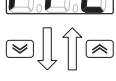

(8) Protection level (PRT)

(8) By changing the setting values, the reading and modification operations of other setting values can be restricted in three stages. Setting range: Lv0 to 2

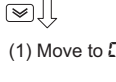

(9) Channel selection key Enabled/Disabled (CHK)

(9) During monitor mode, the connection/disconnection of branch output using the CH Output Light Switch can be restricted.



(1) Move to C-V display

* The display shown here is when the Protection level is Settings to Lv1.

How to Set Various Parameters

Parameter settings in Setting Mode are performed using the following six keys.

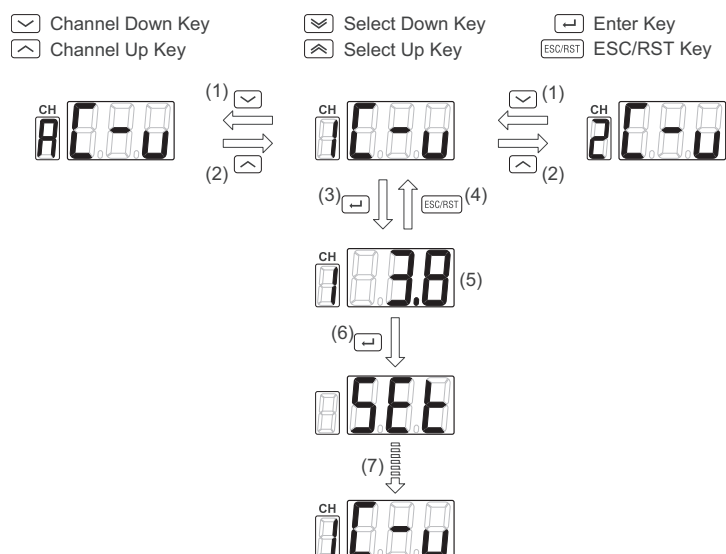

Symbol	Description
(1)	When the parameter display is active, pressing the Channel Down Key will change to the previous branch output.
(2)	When the parameter display is active, pressing the Channel Up Key will change to the next branch output.
(3)	When the parameter display is active, pressing the Enter Key will move to the setting value change state.
(4)	In the setting value change state, pressing the Cancel (ESC)/Reset (RST) Key will return to the parameter display state.
(5)	In the setting value change state, the Select Down/UP Keys can be used to change the setting value. Additionally, holding down the key will accelerate the change in the setting value.
(6)	When the Enter Key is pressed in the setting value change state, the display will dim and then show "SEt".
(7)	After the "SEt" display ends, the setting value is confirmed, and the system will move to the parameter display state.

Selection of Protection level

By settings the Protection level, you can prevent operational mistakes during normal Operation.

3 levels of restriction can be applied to parameter read/setting operations.

Protection level	Intended users	Possible operations
0	Equipment designers and manufacturers	All Set value can be read and changed.
1	Person in charge of equipment maintenance	Some Set value can be read and changed.
2	On-site operator	Set value can be read but cannot be changed.

Parameter Initialize

All Settings parameters of the main unit can be restored to their Default value (factory default).

If you Settings the Protection level to "0", a parameter Initialize "INI" menu will be added. Select it and execute the Initialize.

Note: 1. At Protection level 1 and 2, it will not be displayed within the Setting Mode.

It is Settings Protection level 1 at the time of purchase.

Note: 2. Default value (Factory Default) Bit status

- Each parameter is changed to its Default value
- Change all Branch output to Connected state
- Change the Protection level to 1

Displaying Alarms

The S8AS2 displays alarms according to the parameters set in Setting Mode. The alarm number and detected value are alternated on the display for each item.

Error code	Error	Output status
A10	Abnormal Voltage Tripping	Cut off All branch outputs
A11	Abnormal current tripping	Cut off the Target Outputs
A12	Total output current tripping	Cut off all branch outputs
A21	Undervoltage detection	No cutoff operation
A23	Replacement time notification	No cutoff operation
A23/HOT	Overheating alarm	No cutoff operation
A30	Over-temperature output	No cutoff operation

Resetting Alarms

When an alarm is displayed, remove the cause of the alarm and then press the RST/ESC Key. When it is possible to clear the error, press the RST/ESC Key for 3 seconds. RST will be shown on the 7-segment display. Resetting will be possible.

Note: 1. Although errors are normally cleared when the power supply is turned ON, the setting of a parameter can be changed so that errors are not cleared. (This is not possible for the S8AS2-□□-□SN.) Refer to the *S8AS2 User's Manual* (Man. No. T242) for details.

Note: 2. The over-temperature output will automatically be reset when the temperature drops below the set value.

Operation display and how to operate the Channel selection key

The output status of branch outputs is displayed using LED illumination. Refer to the *S8AS2 User's Manual* (Man. No. T242) for the procedure to recover from an abnormal condition.

Lights in green	Normal connected state
Flashes in green	Connection standby state by startup sequence
Lights in red	Abnormal shutdown status (waiting for recovery).
Flashes in red	Abnormal disconnection status (operation not possible)
Off	Disconnection or Operation stopped state to forced operation

Note: If the "Channel selection key" does not respond, check if the parameter "Channel selection key Enabled/Disabled" is set to "Disabled". (Default value: Enabled)

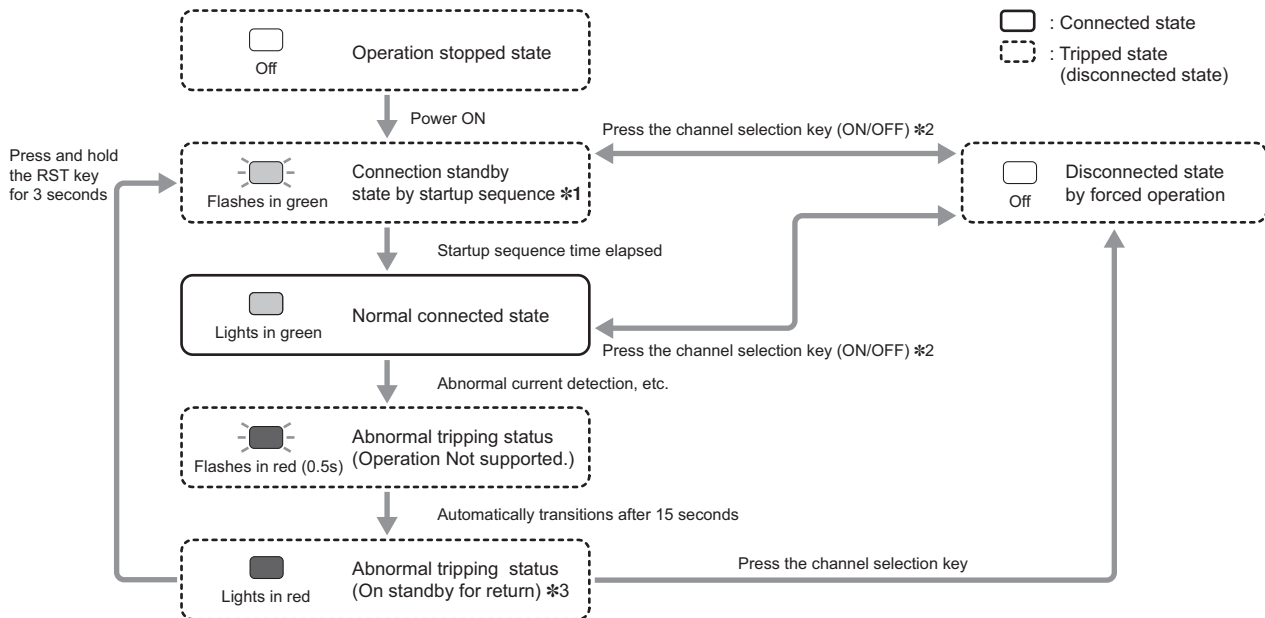

*1. If the Startup sequence settings is 0s, it will connect normally without waiting.

*2. If switching ON/OFF continuously, the channel will not switch from OFF to ON unless more than 3 seconds have passed since the last ON.

*3. In the case of a tripping status due to an internal fault (waiting for recovery), it will blink Red at 0.25-second intervals.

Error Display List

Seven-segment display	Error code	Meaning	Probable cause and remedy	
$\text{E}rP$	ERP	Memory error on power supply side	These are S8AS2 system errors. When one of these error codes is displayed, check the system configuration and clear the error, and then turn the power supply OFF and ON again. If the error code persists, contact your OMRON representative regarding the error.	
.	---	S8AS2 hardware error		
$\text{E}98$	E98	RAM error		
$\text{E}97$	E97	EEPROM read error		
$\text{E}96$	E96	EEPROM write error		
$\text{E}94$	E94	Short circuit failure		
$\text{E}00$	E00	EEPROM initialization error		
$\text{E}01$	E01	EEPROM error		
$\text{E}02$	E02	Model error		
$\text{E}03$	E03	Factory default detection mode		
$\text{E}06$	E06	Product overheating abnormality	An overheating state has continued for over 180 minutes.	Internal components may have degraded, so replace the main unit.
$\text{E}10$	E10	Data is corrupted.	There is an error in the parameter settings.	Press the Mode Key to switch to the parameter initialization display. After initializing the parameters, set them again. However, in the case of Type S8AS2-□□-□SN, it will be treated as a system error.
$\text{A}10$	A10	Abnormal Voltage Tripping	The power supply voltage has exceeded the abnormal voltage tripping threshold.	Check the power supply voltage.
$\text{A}11$	A11	Abnormal current tripping	The current of the Branch output has reached an abnormal current cutoff judgment.	Check whether the connected device is correct and check whether the set value is appropriate.
$\text{A}12$	A12	Total current tripping	All branch outputs were cutoff, since the specified total current value and its power-ON time (s) exceeded the total abnormal current tripping condition.	Check whether the connected devices are appropriate and whether they are being used within the total current value for all branch outputs that were tripped.
$\text{A}21$	A21	Undervoltage alarm	The output voltage dropped below the undervoltage detection threshold.	Check the power supply voltage and the set value.
$\text{A}23$	A23	The unit for this is displayed in 2 ways: Yrs or % is lit: Maintenance forecast monitor output kH is lit: Running time alarm	Indicates that the replacement time of this unit calculated within type S8AS2 has fallen below the set notification time.	The replacement time is approaching.
$\text{A}23/\text{HOT}$	A23/HOT	Overheating alarm	The S8AS2 is overheated.	Take steps to reduce the internal temperature.
$\text{A}30$	A30	Over-temperature output	The S8AS2's internal temperature exceeded the over-temperature output threshold.	Check for a high ambient temperature and check the setting of the over-temperature output threshold. Take steps to reduce the temperature in the control panel.

- When multiple abnormalities occurred simultaneously, they are displayed in the priority order from top to bottom in the above table.
- The abnormality A11 can occur simultaneously in two or more branch outputs. At this time, the Branch output number LED will not Lit. up.

Branch output number LED display	Error code	Meaning	Probable cause and remedy
	---	Measurement circuit is in a standby state.	This is displayed temporarily when the power is interrupted. There is a possibility of a malfunction if it is displayed when the power is turned on. If it is displayed continuously, perform power cycling. If the abnormality still occurred, contact your OMRON representative regarding the error.

S8AS2

Dimensions

(Unit: mm)

240 W 6 branch outputs S8AS2-24024-06□

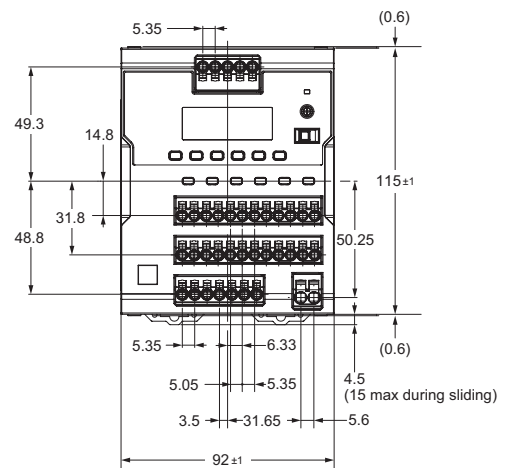
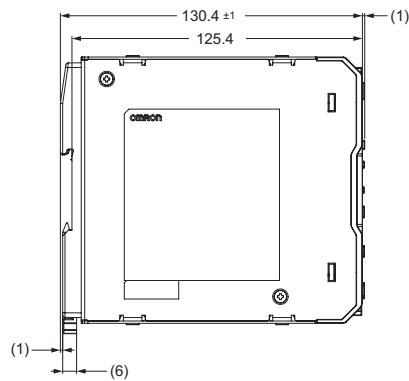

480 W 8 branch outputs S8AS2-48024-08□

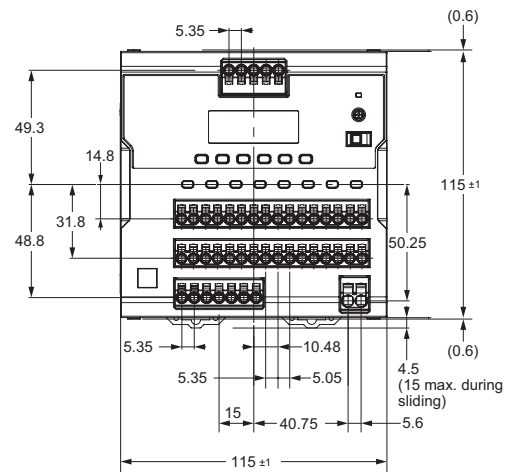
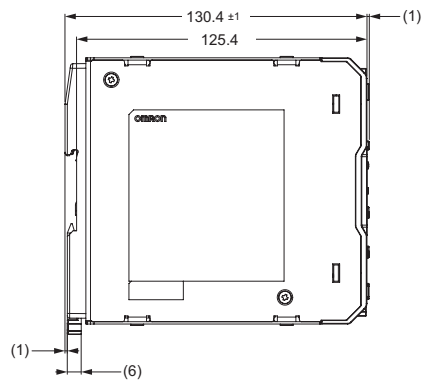

Rain Mounting (order separately)

Support rail (Material: Aluminum)

PFP-100N
PFP-50N

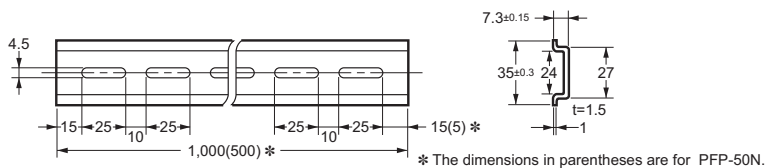
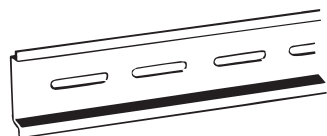

Model
PFP-100N
PFP-50N

Support rail (Material: Aluminum)

PFP-100N2

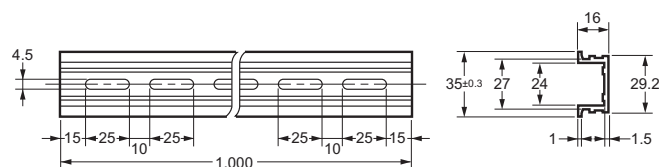
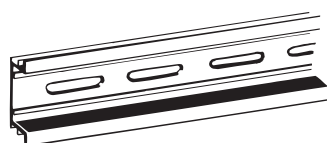

Model
PFP-100N2

End Plate

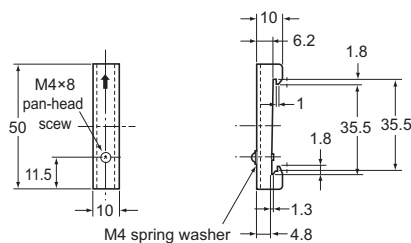
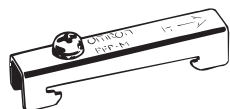

PFP-M







Model
PFP-M

Safety Precautions

Refer to *Safety Precautions for All Power Supplies*.
Warning Indications

 WARNING	Warning Level Indicates a potentially hazardous situation which, if not avoided, will result in minor or moderate injury, or may result in serious injury or death. Additionally, there may be significant property damage.
 CAUTION	Caution level Indicates a potentially hazardous situation which, if not avoided, may result in minor or moderate injury or in property damage.
Precautions for Safe Use	Supplementary comments on what to do or avoid doing, to use the product safely.
Precautions for correct use	Supplementary comments on what to do or avoid doing, to prevent failure to operate, malfunction or undesirable effect on product performance.

Meaning of Product Safety Symbols

	General instructions Used for general mandatory action precautions for which there is no specified symbol.
	Caution against electric shock Used to warn of the risk of electric shock under specific conditions.
	Caution against high temperatures Used to warn of the risk of minor injury caused by high temperatures.
	No disassembly Use to indicate prohibition when there is a risk of minor injury from electrical shock or other source if the product is disassembled.

WARNING

The electrical wire may come out and an electric shock may be caused. Insert the wire straight into the terminal block until the end touches the terminal block.



CAUTION

Minor electric shock, fire, or Product failure may occasionally occur. Do not disassemble, modify, or repair the Product or touch the interior of the Product.



Minor burns may occasionally occur. Do not touch the Product while power is being supplied or immediately after power is turned OFF.



Minor injury due to electric shock may occasionally occur. Do not touch the terminals while power is being supplied. When powered, the device's interior may occur up to 390 V. This voltage remains for 30 seconds after the power is turned off.



Minor electric shock, fire, or product failure may occasionally occur. Do not allow any pieces of metal, conductors, or cuttings from installation work to enter the Power Supply.



Precautions for Safe Use

Ambient Operating and Storage Environments

- Store at an ambient Temperature of -40 to 85°C and relative humidity of 95% max.
- To maintain the performance of the Maintenance Forecast Monitor Function, if storing for more than three months, store at Temperature between -20 and 30°C and relative humidity between 25 and 70%.
- The internal parts may occasionally deteriorate or be damaged. Do not use the Product in areas outside the derating curves.
- Internal parts may possibly be broken. Do not use a current that exceeds the rated total output current. If temporary peak currents occur repetitively, design the system so that the peak currents do not exceed the rated total output current.
- The tripping performance is guaranteed according to the ambient operating temperature. Use the Product within the derating range.
- Use the Product at a humidity of 95% or less.
- Do not use in Low dew-point environments.
- Do not use the Product where it would be subjected to direct sunlight.
- Do not use the Product where it would be subjected to the possibility of penetration of liquid, foreign substance, or corrosive gas.

Installation Environment

- Do not use the Product where it would be subjected to shock or vibration. A device such as a contact breaker may be a vibration source. Set the Product as far as possible from possible sources of shock or vibration.
- If the Product is used in an area with excessive electronic noise, be sure to separate the Product as far as possible from the noise sources.
- Do not connect a battery or other backup power supply to the output of the Product.
- Although some inverters have an output frequency of 50/60 Hz, they may cause internal temperatures to rise, possibly resulting in burning, if they are connected as the power source for the S8AS2. Do not use the output from an inverter as the power source for the S8AS2.
- If the input is connected to a UPS, do not connect a UPS with a square-wave output. Doing so will cause the internal temperature of the product to increase, possibly causing smoking or burning.

Installation method

- Take adequate measures to ensure proper heat dissipation to increase the long-term reliability of the Product. A different derating curve from the one for the standard mounting must be used if the horizontal separation is less than 15 mm.
- Poor heat dissipation may deteriorate or damage internal parts. Do not loosen the screws on the side of the Product.
- S8AS2 can be used in combinations with a horizontal separation of less than 15 mm (front, side-by-side mounting) only in cases of the same model being used. In such cases, use the product in accordance with a derating curve with a horizontal separation of less than 15 mm.

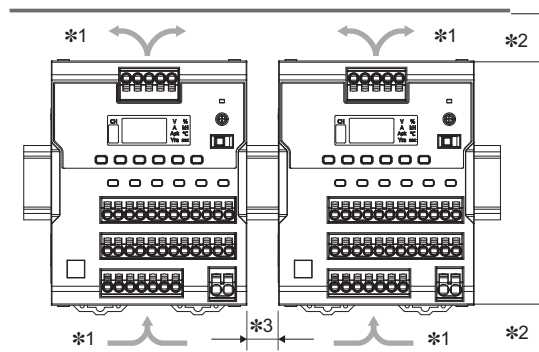

- *1. Air convection
- *2. Vertical separation: 25 mm or more
- *3. Horizontal separation: 15 mm or more (Standard mounting)
Horizontal separation: Less than 15 mm (Front, side-by-side mounting)

Mounting direction

- The S8AS2 model should be installed either with Standard mounting or flush Front mounting, as shown in (A) and (B). Do not install it facing upward as in (C) or in any miscellaneous orientation.

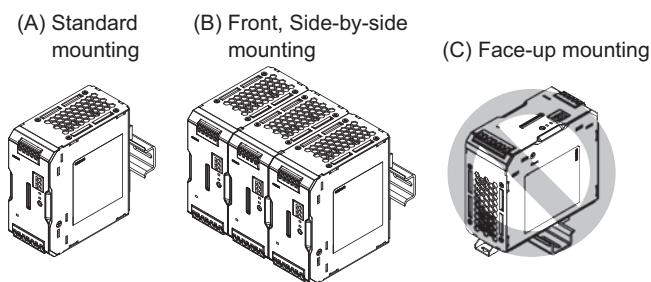

Installation and wiring

- Connect the ground completely. A protective earthing terminal stipulated in safety standards is used. Electric shock or malfunction may occur if the ground is not connected completely.
- Minor fire may possibly occur. Ensure that input and output terminals are wired correctly.
- To prevent wiring materials from smoking or ignition, confirm wire ratings and use the wiring materials given in the following table.

Recommended Wire

Terminals	Recommended Wire		
	Model	(mm ²)	(AWG)
Input terminals	S8AS2-24024-06□	0.5 to 2.5	20 to 14
	S8AS2-48024-08□	0.75 to 2.5	18 to 14
PE (Protective Earth) terminal	S8AS2-□□-□□	2 to 2.5	14
Branch output terminal (+) Branch output terminal (-)	S8AS2-□□-□□	0.5 to 2.5	20 to 14
Common output terminals (-)	S8AS2-24024-06□	2 to 4	14 to 12
	S8AS2-48024-08□	4	12
I/O signal terminals	S8AS2-□□-□□	0.25 to 4	24 to 12

Note: 1. The wire should be copper, either stranded or solid.

Note: 2. Use heat-resistant wire rated for 75°C or higher.

Stripping length

Terminals	Recommended Wire	Ferrule length	Recommended Stripping length	
			When using Ferrule	When Ferrule not used.
Other than the Common output terminals (negative)	0.25 to 1.5 mm ² / AWG24 to 16	8 mm	10 mm	8 mm
		10 mm	12 mm	10 mm
Common output terminals (-)	2 to 2.5 mm ² / AWG14	10 mm	12 mm	10 mm
		4 mm ² /AWG12	12 mm	14 mm

- Do not press down on the terminal block with a force of 40 N or greater (100 N or greater for output terminal blocks) when inserting wires or inserting a flat-blade screwdriver into a release hole.
- Do not wire anything to the release holes.
- Do not tilt or twist a flat-blade screwdriver while it is inserted into a release hole on the terminal block. The terminal block may be damaged.
- Insert a flat-blade screwdriver into the release holes at an angle. The terminal block may be damaged if you insert the screwdriver straight in.
- Do not allow the flat-blade screwdriver to fall out while it is inserted into a release hole.
- Do not bend a wire past its natural bending radius or pull on it with excessive force. Doing so may cause the wire disconnection.
- Do not insert more than one wire into each terminal insertion hole.
- Do not pre-solder the ends of the wires. Doing so will inhibit proper connection.
- If there is a possibility that the Unit will be subject to vibration or shock, use Wires with Ferrules or Stranded Wires.
- It is conceivable that internal parts may be deteriorated or damaged. Do not repeatedly perform cutoff or recovery operations more than necessary.
- To allow heat to dissipate, always remove the sheet covering the Product for wiring before you turn ON the power.

Output voltage adjustment

- The output voltage adjuster (V.ADJ.) may possibly become damaged. Do not apply more than the required force.
- After adjusting the output voltage, ensure that the total output power and output current of each branch output do not exceed the rated output power and rated total output current.
- Default Setting: Set at the rated voltage Adjustment Range: Adjustable with "V.ADJ" (11) on the front surface of the Product from 24 to 28 VDC of the rated output voltage. Turning clockwise increases the output voltage, and turning counterclockwise decreases the output voltage.

Note: The output voltage may increase beyond the allowable voltage range when "V.ADJ" (11) operation is performed. When adjusting the output voltage, check the output voltage of the Product and be sure that the load is not damaged. When adjusting to lower the output voltage, this function may activate depending on the set value of the undervoltage detection feature.

For details, please refer to the *S8AS2 Users Manual* (Man. No. T242).

Precautions for Correct Use

DIN rail mounting

To mounting on a DIN Rail, hook portion (A) of the Block onto the rail and press in the (B) direction.

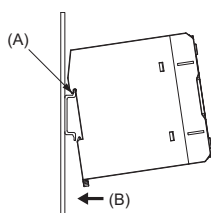

To dismantle the Block, pull down portion (C) with a flat-blade screwdriver and pull out the Block.

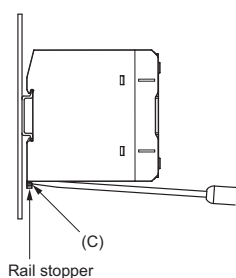

Connecting Wires to the Push-In Plus Terminal Block

Part Names of the Terminal Block

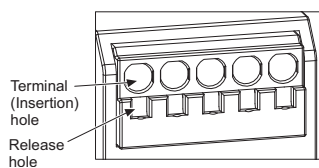

Connecting Wires with Ferrules and Solid Wires

Insert the solid wire or ferrule straight into the terminal block until the end touches the terminal block.

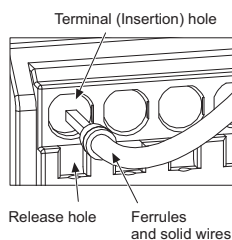

- If a wire is difficult to connect because it is too thin, use a flat-blade screwdriver in the same way as when connecting stranded wire.

Connecting Stranded Wires

Use the following procedure to connect the wires to the terminal block.

1. Hold a flat-blade screwdriver at an angle and insert it into the release hole.
The angle should be between 10° and 15° . If the flat-blade screwdriver is inserted correctly, you will feel the spring in the release hole.
2. With the flat-blade screwdriver still inserted into the release hole, insert the wire into the terminal hole until it strikes the terminal block.
3. Remove the flat-blade screwdriver from the release hole.

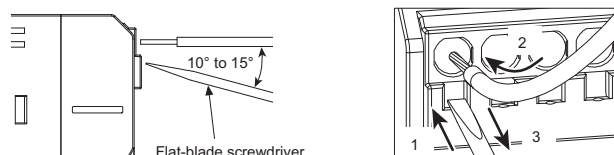

Checking Connections

- After the insertion, pull gently on the wire to make sure that it will not come off and the wire is securely fastened to the terminal block
- The insulation distance is still satisfied although some of the conductor may still be visible after being inserted into the terminal block, even though recommended ferrules are used.

Removing Wires from the Push-In Plus Terminal Block

Use the following procedure to remove wires from the terminal block. The same method is used to remove stranded wires, solid wires, and ferrules.

1. Hold a flat-blade screwdriver at an angle and insert it into the release hole.
2. With the flat-blade screwdriver still inserted into the release hole, remove the wire from the terminal insertion hole.
3. Remove the flat-blade screwdriver from the release hole.

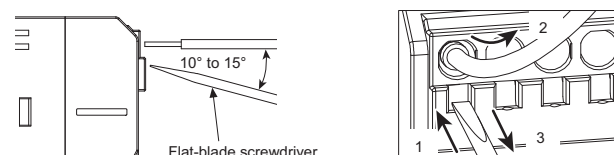

Recommended Ferrules and Crimping Tools

Recommended Ferrules

Applicable wire		Ferrule Conductor length (mm)	Stripping length (mm) (Ferrules used)	Recommended Ferrules		
(mm ²)	(AWG)			Phoenix Contact	Weidmuller	Wago
0.25	24	8	10	Al 0, 25-8	H0.25/12	216-301
		10	12	Al 0, 25-10	---	---
0.34	22	8	10	Al 0,34-8	H0.34/12	216-302
		10	12	Al 0,34-10	---	---
0.50	20	8	10	Al 0,5-8	H0.5/14	216-201
		10	12	Al 0,5-10	H0.5/16	216-241
0.75	18	8	10	Al 0,75-8	H0.75/14	216-202
		10	12	Al 0,75-10	H0.75/16	216-242
1/1.25	18/17	8	10	Al 1-8	H1.0/14	216-203
		10	12	Al 1-10	H1.0/16	216-243
1.25/1.5	17/16	8	10	Al 1,5-8	H1.5/14	216-204
		10	12	Al 1,5-10	H1.5/16	216-244
2.5	14	10	12	Al 2, 5-10	H2.5/16DS	216-246
Recommended crimp tool				CRIMPFOX6 CRIMPFOX6T-F CRIMPFOX10S	PZ6 roto	Variocrimp4

Note: 1. Make sure that the outer diameter of the wire is smaller than the inner diameter of the insulating sleeve of the recommended ferrule.

Note: 2. Make sure that the ferrule processing dimensions conform to the following figure.

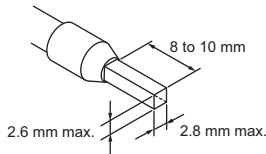

Applicable wire		Ferrule Conductor or length (mm)	Stripping length (mm) (Ferrules used)	Recommended Ferrules		
(mm ²)	(AWG)			Phoenix Contact	Weidmuller	Wago
4	12	12	14	Al 4-12	H4.0/20D	216-267
Recommended crimp tool				CRIMPFOX6 CRIMPFOX6T-F CRIMPFOX10S	PZ6 roto	Variocrimp4

Note: 1. Make sure that the outer diameter of the wire is smaller than the inner diameter of the insulating sleeve of the recommended ferrule.

Note: 2. Make sure that the ferrule processing dimensions conform to the following figure.

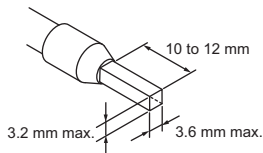

Recommended Flat-blade Screwdriver

Use a flat-blade screwdriver to connect and remove wires. Use the following flat-blade screwdrivers.

Terminals except for COM output terminals (-)

Model	Manufacturer
ESD 0,40×2,5	Wera
SZS 0,4×2,5 SZF 0-0,4×2,5 *	Phoenix Contact
0.4×2.5×75 302	Wiha
AEF.2,5×75	Facom
210/-719	Wago
SDIS 0.4×2.5×75	Weidmuller
9900(-2.5×75)	Vessel

* OMRON's exclusive purchase XW4Z-00B is available to order as SZF 0-0,4×2,5 (manufactured by Phoenix Contact).

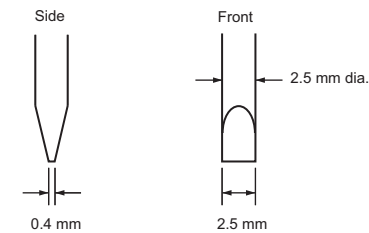

COM output terminals(-)

Model	Manufacturer
ESD 0.60×3.5	Wera
SZS 0,6×3,5 SZF 1-0,6×3,5	Phoenix Contact
0.6×3.5×100 302	Wiha
AEF 3.5×75	Facom
210-720	Wago
SDIS 0.4×2.5×75	Weidmuller
1-64-984	STANLEY

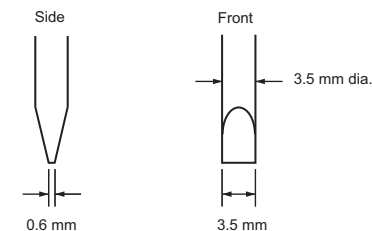

Prohibition of parallel connection

Do not connect branch outputs from the S8AS2 in parallel. Also, do not connect the branch outputs in parallel with branch outputs of other S8AS2 Power Supplies.

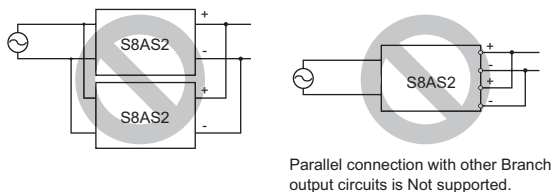

Insulation resistance test

When testing the insulation resistance, use a DC resistance meter at 500 VDC.

Note: To prevent damage, always short branch output terminals (+/-), all I/O terminals, and communications terminals before testing.

Dielectric Strength Test

The S8AS2 is designed to withstand 3,000 VAC for 1 minute between Input terminal and branch output, I/O signal terminals (3), (4), (5) and (6). When testing, set the cutoff current for the withstand voltage test device to 20 mA.

(Refer to *Constructions and Nomenclature* on page 20)

Note: 1. The S8AS2 may possibly be damaged from the impulse voltage if a testing device switch is used to abruptly apply or shut off 3,000 VAC. Increase the applied voltage gradually using the voltage adjustment on the testing device.

Note: 2. When testing terminals together, always short the specified terminals so that the voltage is applied to all of the terminals at the same time.

The noise when input is turned ON

A harmonic current suppression circuit is built into the Power Supply. This circuit can create noise when the input is turned ON, but it will last only until the internal circuits stabilize and does not indicate any problem in the Product.

Inrush current, startup time, Outputs hold time

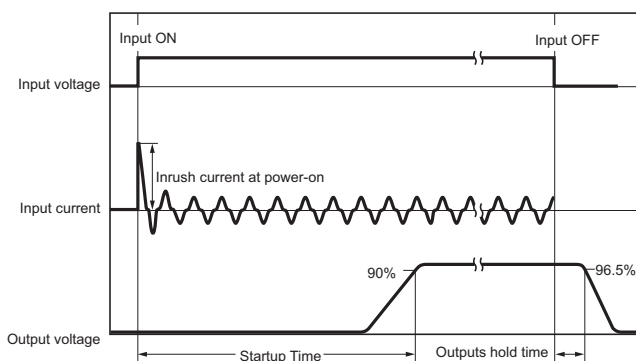

Note: When using wiring with crossovers on N units, an inrush current N times that of single-unit use will flow. In particular, to prevent external fuses from blowing or breakers from not operating due to the inrush current, thoroughly check the blowing characteristics of the fuses and the operating characteristics of the breakers, and select them accordingly.

No Output Voltage

The internal circuit's overcurrent protection or overvoltage protection may operate. Alternatively, the latch protection circuit may operate if there is a lightning surge or other large voltage applied to the input. Contact OMRON if there is still no output voltage after checking the following two points:

- Checking Overcurrent Protection
Check whether the load is in an overcurrent or short-circuited state. Remove the wires to the load before checking.
- Checking Overvoltage Protection and Latching Protection
Turn the power supply OFF and leave it OFF for at least 3 minutes, then turn it ON again.

Tripping performance

- When the tripping alarm output operates, always remove the cause of the output first and then reset the alarm.
- When cycling the input power supply, always remove any problems first and then turn ON the input power supply.

Abnormal Voltage Tripping Functions

1. The S8AS2 is equipped with an abnormal voltage tripping function. If the output voltage exceeds the specified threshold, all branch outputs are automatically shut off. This function, however, does not protect loads and internal parts from high voltages in all cases. Be sure the output voltage is within the rated range.
2. Outputs may be cut off by the abnormal voltage protection with loads that generate reverse peak electromotive force.

Abnormal Current Tripping Function

- The S8A2S is equipped with an abnormal current tripping function. If the current flowing through any branch output exceeds the preset abnormal cutoff current value, the corresponding branch output is shut off. Also, all branch outputs will be cut off if their total peak output current exceeds a specified value.

Note: 1. Continuing operation with overcurrent may occasionally result in deterioration or destruction of internal elements.

Note: 2. Do not use the Power Supply Unit for applications in which load inrush current or overload will frequently occur. Doing so may result in deterioration or damage to internal components.

Total Outputs Peak current

The S8AS2 is designed to provide a temporary peak current to provide the overcurrent required to start load devices. The total peak output current for all branch outputs combined is given below. If the total current exceeds any of these values, all branch outputs will be cut off according to the size of the peak current or application time to ensure safety.

1. 240 W Models
Total Peak current value/pulse width of Peak current:
up to 17 A for 2s, up to 15 A for 5s, up to 13 A for 10s,
up to 12 A for 20s
2. 480 W Models
Total Peak current value/pulse width of Peak current:
up to 27 A/1s, up to 25 A/2s, up to 22.5 A/5s

Note: 1. If the total output current exceeds the maximum peak current value, internal operation will become unstable and the branch outputs may be cut off.

Note: 2. Maintain the total current for normal operation after the load devices have started to within the rated ranges.

External Tripping Input

For the use of this Functions, refer to the *S8AS2 Users Manual* (Man. No. T242).

Tripping Alarm Output, Undervoltage Detection Output, Maintenance Forecast Monitor Output, Over-temperature output

MOSFET relay output: 30 VDC max, 50 mA max, residual voltage 2 V or less when ON, leakage current 0.1 mA or less when OFF

- Wire all output signal circuits correctly. Internal current control circuits are not provided internally for output signals. Do not allow the output current to exceed 50 mA.
- After completing wiring, confirm that the circuits operate correctly.

Display of Output voltage value

The function that detects and displays the output voltage monitors the voltage after AC/DC conversion in the internal circuit. The displayed voltage will be somewhat lower than the value at the output terminals of the power source due to internal voltage drop. To accurately confirm the output voltage, measure it at the branch output terminal.

Maintenance Forecast Monitor Function

The accuracy of the maintenance forecast monitor function will be reduced in applications where the input voltage turns ON and OFF frequently.

Under general usage conditions, the S8AS2 will reach the replacement notification threshold in a few years to over a decade. For long-term use, regularly check that the replacement period is not below 0.5 years by monitoring the display or by following the steps below to ensure that Output Signal LEF-COM is functioning properly:

- (a) Set to Monitor Mode.
- (b) Confirm that the output between LEF-COM is ON (LEF-COM is conducting).

Disposal

When disposing of the item, treat the S8AS2 as industrial waste.

Warranty and Limitations of Liability

WARRANTY

The Power Supply warranty is valid for a period of five years from the date of shipment from the factory.

LIMITATIONS OF LIABILITY

The warranty is valid only for the following operating conditions.

1. Average ambient operating temperature of the Power Supply: 40°C max.
2. Average load rate of 80% max.
3. Mounting method: Standard mounting

Note: The maximum ratings must be within the derating curve.

If the Power Supply fails for reasons attributable to OMRON within the above warranty period, OMRON will repair or replace the faulty part of the Power Supply at the place of purchase or the place where the Power Supply delivered without charge.

This warranty does not cover the following types of failures.

1. Failures that result from handling or operation of the product under conditions or in environments that are not given in this document and not given in any other specifications exchanged between OMRON and the customer.
 2. Failures that originate in causes other than the delivered product itself
 3. Failures caused by disassembly, modification, or repair of the Power Supply by anyone other than OMRON
 4. Failures caused by applications or uses for which the product was not originally intended.
 5. Failures caused by factors that could not be anticipated with the scientific or technical knowledge available when the Power Supply was shipped.
 6. Failures caused by other causes for which OMRON is not responsible, such as natural disasters and other acts of God.
- This warranty is limited to the individual Power Supply that was delivered and does not cover any secondary, subsequent, or related damages.

Recommended Replacement Periods and Periodic Replacement for Preventive Maintenance

The recommended replacement period for preventive maintenance is greatly influenced by the installation environment of the Power Supply. As a guideline, the recommended replacement period is 7 to 10 years.*

To prevent failures or accidents that can be caused by using a Power Supply beyond its service life, we recommend that you replace the Power Supply as early as possible within the recommended replacement period. However, bear in mind that the recommended replacement period is for reference only and does not guarantee the life of the Power Supply.

Many electronic components are used in the Power Supply and the Power Supply depends on the correct operation of these components to achieve the original Power Supply functions and performance. However, the influence of the ambient temperature on aluminum electrolytic capacitors is large, and the service life is reduced by half for each 10°C rise in temperature (Arrhenius law). When the capacity reduction life of the electrolytic capacitor is reached, the Power Supply failures or accidents may occur. We therefore recommend that you replace the Power Supply periodically to minimize product failures or accidents in advance.

The recommended replacement period applies under the following conditions: rated input voltage, load rate of 50% max., ambient temperature of 40°C max., and the standard mounting method.

This product model is designed with a service life of 10 years minimum under the above conditions.

Terms and Conditions Agreement

Read and understand this catalog.

Please read and understand this catalog before purchasing the products. Please consult your OMRON representative if you have any questions or comments.

Warranties.

- (a) Exclusive Warranty. Omron's exclusive warranty is that the Products will be free from defects in materials and workmanship for a period of twelve months from the date of sale by Omron (or such other period expressed in writing by Omron). Omron disclaims all other warranties, express or implied.
- (b) Limitations. OMRON MAKES NO WARRANTY OR REPRESENTATION, EXPRESS OR IMPLIED, ABOUT NON-INFRINGEMENT, MERCHANTABILITY OR FITNESS FOR A PARTICULAR PURPOSE OF THE PRODUCTS. BUYER ACKNOWLEDGES THAT IT ALONE HAS DETERMINED THAT THE PRODUCTS WILL SUITABLY MEET THE REQUIREMENTS OF THEIR INTENDED USE.

Omron further disclaims all warranties and responsibility of any type for claims or expenses based on infringement by the Products or otherwise of any intellectual property right. (c) Buyer Remedy. Omron's sole obligation hereunder shall be, at Omron's election, to (i) replace (in the form originally shipped with Buyer responsible for labor charges for removal or replacement thereof) the non-complying Product, (ii) repair the non-complying Product, or (iii) repay or credit Buyer an amount equal to the purchase price of the non-complying Product; provided that in no event shall Omron be responsible for warranty, repair, indemnity or any other claims or expenses regarding the Products unless Omron's analysis confirms that the Products were properly handled, stored, installed and maintained and not subject to contamination, abuse, misuse or inappropriate modification. Return of any Products by Buyer must be approved in writing by Omron before shipment. Omron Companies shall not be liable for the suitability or unsuitability or the results from the use of Products in combination with any electrical or electronic components, circuits, system assemblies or any other materials or substances or environments. Any advice, recommendations or information given orally or in writing, are not to be construed as an amendment or addition to the above warranty.

See <http://www.omron.com/global/> or contact your Omron representative for published information.

Limitation on Liability; Etc.

OMRON COMPANIES SHALL NOT BE LIABLE FOR SPECIAL, INDIRECT, INCIDENTAL, OR CONSEQUENTIAL DAMAGES, LOSS OF PROFITS OR PRODUCTION OR COMMERCIAL LOSS IN ANY WAY CONNECTED WITH THE PRODUCTS, WHETHER SUCH CLAIM IS BASED IN CONTRACT, WARRANTY, NEGLIGENCE OR STRICT LIABILITY.

Further, in no event shall liability of Omron Companies exceed the individual price of the Product on which liability is asserted.

Suitability of Use.

Omron Companies shall not be responsible for conformity with any standards, codes or regulations which apply to the combination of the Product in the Buyer's application or use of the Product. At Buyer's request, Omron will provide applicable third party certification documents identifying ratings and limitations of use which apply to the Product. This information by itself is not sufficient for a complete determination of the suitability of the Product in combination with the end product, machine, system, or other application or use. Buyer shall be solely responsible for determining appropriateness of the particular Product with respect to Buyer's application, product or system. Buyer shall take application responsibility in all cases.

NEVER USE THE PRODUCT FOR AN APPLICATION INVOLVING SERIOUS RISK TO LIFE OR PROPERTY OR IN LARGE QUANTITIES WITHOUT ENSURING THAT THE SYSTEM AS A WHOLE HAS BEEN DESIGNED TO ADDRESS THE RISKS, AND THAT THE OMRON PRODUCT(S) IS PROPERLY RATED AND INSTALLED FOR THE INTENDED USE WITHIN THE OVERALL EQUIPMENT OR SYSTEM.

Programmable Products.

Omron Companies shall not be responsible for the user's programming of a programmable Product, or any consequence thereof.

Performance Data.

Data presented in Omron Company websites, catalogs and other materials is provided as a guide for the user in determining suitability and does not constitute a warranty. It may represent the result of Omron's test conditions, and the user must correlate it to actual application requirements. Actual performance is subject to the Omron's Warranty and Limitations of Liability.

Change in Specifications.

Product specifications and accessories may be changed at any time based on improvements and other reasons. It is our practice to change part numbers when published ratings or features are changed, or when significant construction changes are made. However, some specifications of the Product may be changed without any notice. When in doubt, special part numbers may be assigned to fix or establish key specifications for your application. Please consult with your Omron's representative at any time to confirm actual specifications of purchased Product.

Errors and Omissions.

Information presented by Omron Companies has been checked and is believed to be accurate; however, no responsibility is assumed for clerical, typographical or proofreading errors or omissions.

Some images are used under license from Shutterstock.com.

Note: Do not use this document to operate the Unit.

OMRON Corporation Industrial Automation Company

Kyoto, JAPAN

Contact : www.ia.omron.com

Regional Headquarters

OMRON EUROPE B.V.

Wegalaan 67-69, 2132 JD Hoofddorp
The Netherlands
Tel: (31) 2356-81-300 Fax: (31) 2356-81-388

OMRON ELECTRONICS LLC

2895 Greenspoint Parkway, Suite 200
Hoffman Estates, IL 60169 U.S.A.
Tel: (1) 847-843-7900 Fax: (1) 847-843-7787

OMRON ASIA PACIFIC PTE. LTD.

438B Alexandra Road, #08-01/02 Alexandra
Technopark, Singapore 119968
Tel: (65) 6835-3011 Fax: (65) 6835-3011

OMRON (CHINA) CO., LTD.

Room 2211, Bank of China Tower,
200 Yin Cheng Zhong Road,
PuDong New Area, Shanghai, 200120, China
Tel: (86) 21-6023-0333 Fax: (86) 21-5037-2388

Authorized Distributor:

©OMRON Corporation 2025 All Rights Reserved.
In the interest of product improvement,
specifications are subject to change without notice.

CSM_2_1

Cat. No. T243-E1-02 1025 (0925)